

OMS srl

DIESEL SPARE PARTS



ITALY

BOSCH

SIEMENS

DENSO

DELPHI

CATALOGO SPESSORI
CALIBRATION SHIMS
SUPLEMENTOS DE CALIBRACIÓN
калибровки прокладки
校準墊片



VERSIONE
12.1



CONDIZIONI DI VENDITA

- I nostri prezzi sono espressi in Euro
- Il trasporto si intende sempre EXW (Franco Fabbrica)
 - L' imballo è sempre addebitato al costo
- I reclami dovranno essere effettuati al trasportatore
- I reclami devono essere effettuati per iscritto e i resi vanno sostituiti in garanzia
- I pagamenti verranno concordati al momento dell' ordine



SALES CONDITION

- All our prices are EXW claims must adressed to forwarder
 - Packaging cost not included
 - Faulty items are garanted with replaced goods
- OMS items are interchangeable with genuine one but manufactured by OMS so not genuine
 - Other manufacture' s name or numbers (genuine) are for costumer reference only.



условия продажи

- транспорт всегда будем EXW
- упаковка 'ы всегда взимается по себестоимости
- Жалобы должны быть сделаны, чтобы перевозчику
 - претензии должны быть в письменной форме и сделаны быть заменен по гарантии платежи будут согласованы во время "порядка"



運輸應始終 EXW
的包裝總是按成本收費
投訴必須向承運人
索賠必須以書面形式提出, 並提出要在保修期內更換
款項將商定的"訂貨時"

BOSCH

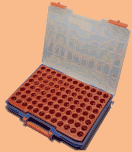

PAG. VII

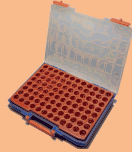

PAG. VIII

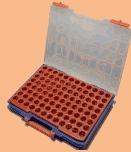

PAG. IX

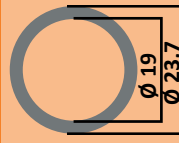

PAG. 1A



PAG. 3 A

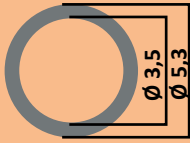

PAG. 5 A

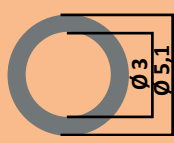

PAG. 7 A

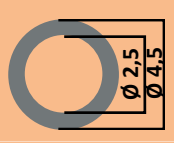

PAG. 9 A

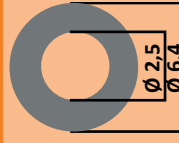

PAG. 11 A



PAG. 13 A



PAG. 15 A



PAG. 17 A



PAG. 19 A



PAG. 21 A



PAG. 23 A

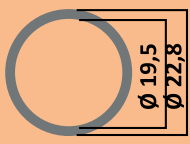

PAG. 25 A

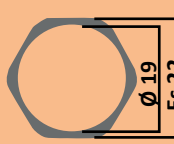

PAG. 27 A

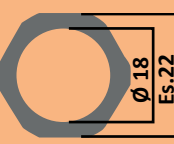

PAG. 29 A

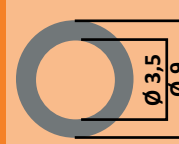

PAG. 31 A

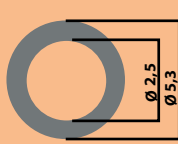

PAG. 32 A



PAG. 33 A

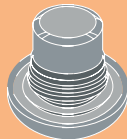

PAG. 34 A

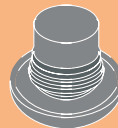

PAG. 35 A



PAG. 36 A

SIEMENS

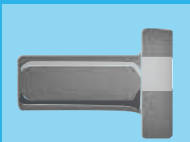

PAG. 1 B

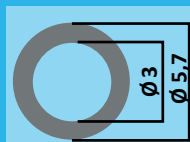

PAG. 2 B

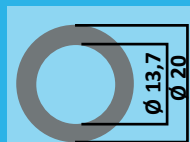

PAG. 3 B



PAG. 4 B

DELPHI

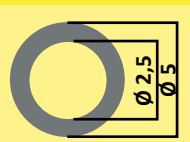

PAG.1 C

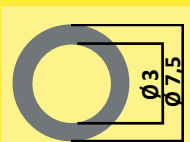

PAG. 2 C

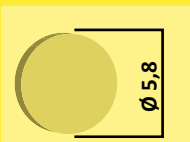

PAG. 3 C

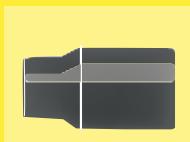

PAG. 4 C

DENSO



PAG. 1 D

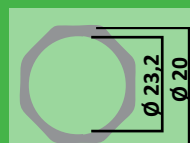

PAG. 2 D

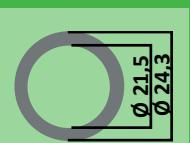

PAG. 3 D

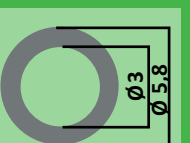

PAG. 5 D

BOSCH



PAG. 1 E



PAG. 2 E



PAG. 3 E



PAG. 4 E



PAG. 5 E



PAG. 6 E



PAG. 7 E



PAG. 8 E



PAG. 9 E



PAG. 10 E



PAG. 11 E



PAG. 1 G



PAG. 2 G



PAG. 3 G



PAG. 4 G

VARI



PAG. 1 F



PAG. 2 F



PAG. 3 F



PAG. 4 F

NAVISTAR



PAG. 1 H



PAG. 2 H

CATERPILLAR



PAG. 1 I



PAG. 2 I



combined handbag

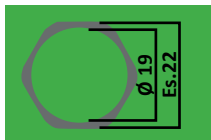
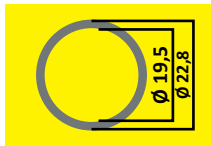

Codice OMS	Rif. codice BOSCH	n° pezzi
11-23-347	F 00R J02 760	1000



valigetta combinata 96 posizioni
combined handbag 96 position

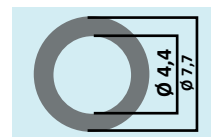

misura	rif. originale	cod.OMS
0,954	F 00R J00 026	11-23-288/0954
0,958	F 00R J00 028	11-23-288/0958
0,962	F 00R J00 030	11-23-288/0962
0,966	F 00R J00 032	11-23-288/0966
0,970	F 00R J00 034	11-23-288/0970
0,974	F 00R J00 036	11-23-288/0974
0,978	F 00R J00 038	11-23-288/0978
0,982	F 00R J00 040	11-23-288/0982
0,986	F 00R J00 042	11-23-288/0986
0,990	F 00R J00 044	11-23-288/0990
0,994	F 00R J00 046	11-23-288/0994
0,998	F 00R J00 048	11-23-288/0998
1,002	F 00R J00 050	11-23-288/1002
1,006	F 00R J00 052	11-23-288/1006
1,010	F 00R J00 054	11-23-288/1010
1,014	F 00R J00 056	11-23-288/1014
1,018	F 00R J00 058	11-23-288/1018
1,022	F 00R J00 060	11-23-288/1022
1,026	F 00R J00 062	11-23-288/1026
1,030	F 00R J00 064	11-23-288/1030
1,034	F 00R J00 066	11-23-288/1034
1,038	F 00R J00 068	11-23-288/1038
1,042	F 00R J00 070	11-23-288/1042
1,046	F 00R J00 072	11-23-288/1046

misura	rif. originale	cod.oms
1,005	F 00R J01 010	11-23-332/1005
1,015	F 00R J01 011	11-23-332/1015
1,025	F 00R J01 012	11-23-332/1025
1,035	F 00R J01 013	11-23-332/1035
1,045	F 00R J01 014	11-23-332/1045
1,055	F 00R J01 015	11-23-332/1055
1,065	F 00R J01 016	11-23-332/1065
1,075	F 00R J01 017	11-23-332/1075
1,085	F 00R J01 018	11-23-332/1085
1,095	F 00R J01 019	11-23-332/1095
1,105	F 00R J01 020	11-23-332/1105
1,115	F 00R J01 021	11-23-332/1115

misura	rif. originale	cod.OMS
1,04	F 00R J00 192	11-23-228/104
1,06	F 00R J00 273	11-23-228/106
1,08	F 00R J00 193	11-23-228/108
1,10	F 00R J00 274	11-23-228/110
1,12	F 00R J00 194	11-23-228/112
1,14	F 00R J00 275	11-23-228/114
1,16	F 00R J00 195	11-23-228/116
1,18	F 00R J00 276	11-23-228/118
1,20	F 00R J00 196	11-23-228/120
1,22	F 00R J00 277	11-23-228/122
1,24	F 00R J00 197	11-23-228/124
1,26	F 00R J00 278	11-23-228/126

misura	rif. originale	cod.OMS
1,24	F 00R J00 126	11-23-235/124
1,25	F 00R J00 128	11-23-235/125
1,26	F 00R J00 130	11-23-235/126
1,27	F 00R J00 132	11-23-235/127
1,28	F 00R J00 134	11-23-235/128
1,29	F 00R J00 136	11-23-235/129
1,30	F 00R J00 138	11-23-235/130
1,31	F 00R J00 140	11-23-235/131
1,32	F 00R J00 142	11-23-235/132
1,33	F 00R J00 144	11-23-235/133
1,34	F 00R J00 146	11-23-235/134
1,35	F 00R J00 148	11-23-235/135

misura	rif. originale	cod.OMS
1,516	F 00R J00 871	11-23-287/1516
1,520	F 00R J00 873	11-23-287/1520
1,524	F 00R J00 875	11-23-287/1524
1,528	F 00R J00 877	11-23-287/1528
1,532	F 00R J00 879	11-23-287/1532
1,536	F 00R J00 881	11-23-287/1536
1,540	F 00R J00 883	11-23-287/1540
1,544	F 00R J00 885	11-23-287/1544
1,548	F 00R J00 887	11-23-287/1548
1,552	F 00R J00 889	11-23-287/1552
1,556	F 00R J00 891	11-23-287/1556
1,560	F 00R J00 893	11-23-287/1560
1,564	F 00R J00 895	11-23-287/1564
1,568	F 00R J00 897	11-23-287/1568
1,572	F 00R J00 899	11-23-287/1572
1,576	F 00R J00 901	11-23-287/1576
1,580	F 00R J00 903	11-23-287/1580
1,584	F 00R J00 905	11-23-287/1584
1,588	F 00R J00 907	11-23-287/1588
1,592	F 00R J00 909	11-23-287/1592
1,596	F 00R J00 911	11-23-287/1596
1,600	F 00R J00 913	11-23-287/1600
1,604	F 00R J00 915	11-23-287/1604
1,608	F 00R J00 917	11-23-287/1608
1,612	F 00R J00 919	11-23-287/1612
1,616	F 00R J00 921	11-23-287/1616
1,620	F 00R J00 923	11-23-287/1620
1,624	F 00R J00 925	11-23-287/1624
1,628	F 00R J00 927	11-23-287/1628
1,632	F 00R J00 929	11-23-287/1632
1,636	F 00R J00 931	11-23-287/1636
1,640	F 00R J00 933	11-23-287/1640
1,644	F 00R J00 935	11-23-287/1644
1,648	F 00R J00 937	11-23-287/1648
1,652	F 00R J00 939	11-23-287/1652
1,656	F 00R J00 941	11-23-287/1656

VALIGETTA COMBINATA



combined handbag OMS version

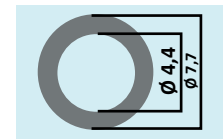
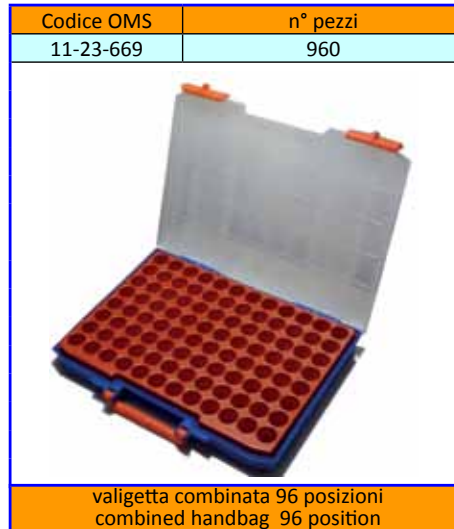
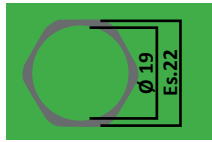
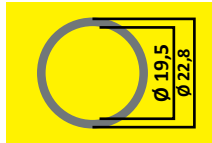
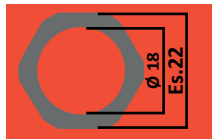

misura	cod.OMS
0,90	11-23-288/090
0,91	11-23-288/091
0,92	11-23-288/092
0,93	11-23-288/093
0,94	11-23-288/094
0,95	11-23-288/095
0,96	11-23-288/096
0,97	11-23-288/097
0,98	11-23-288/098
0,99	11-23-288/099
1,00	11-23-288/100
1,01	11-23-288/101
1,02	11-23-288/102
1,03	11-23-288/103
1,04	11-23-288/104
1,05	11-23-288/105
1,06	11-23-288/106
1,07	11-23-288/107
1,08	11-23-288/108
1,09	11-23-288/109
1,10	11-23-288/110
1,11	11-23-288/111
1,12	11-23-288/112
1,13	11-23-288/113

misura	cod.OMS
1,00	11-23-235/100
1,01	11-23-235/101
1,02	11-23-235/102
1,03	11-23-235/103
1,04	11-23-235/104
1,05	11-23-235/105
1,06	11-23-235/106
1,07	11-23-235/107
1,08	11-23-235/108
1,09	11-23-235/109
1,10	11-23-235/110
1,11	11-23-235/111

misura	cod.oms
1,00	11-23-332/100
1,02	11-23-332/102
1,04	11-23-332/104
1,06	11-23-332/106
1,08	11-23-332/108
1,10	11-23-332/110
1,12	11-23-332/112
1,14	11-23-332/114
1,16	11-23-332/116
1,18	11-23-332/118
1,20	11-23-332/120
1,22	11-23-332/122

misura	cod.OMS
1,20	11-23-228/120
1,22	11-23-228/122
1,24	11-23-228/124
1,26	11-23-228/126
1,28	11-23-228/128
1,30	11-23-228/130
1,32	11-23-228/132
1,34	11-23-228/134
1,36	11-23-228/136
1,38	11-23-228/138
1,40	11-23-228/140
1,42	11-23-228/142
1,44	11-23-228/144
1,46	11-23-228/146
1,48	11-23-228/148
1,50	11-23-228/150
1,52	11-23-228/152
1,54	11-23-228/154
1,56	11-23-228/156
1,58	11-23-228/158
1,60	11-23-228/160
1,62	11-23-228/162
1,64	11-23-228/164
1,66	11-23-228/166

misura	cod.OMS
1,30	11-23-287/130
1,32	11-23-287/132
1,34	11-23-287/134
1,36	11-23-287/136
1,38	11-23-287/138
1,40	11-23-287/140
1,42	11-23-287/142
1,44	11-23-287/144
1,46	11-23-287/146
1,48	11-23-287/148
1,50	11-23-287/150
1,52	11-23-287/152
1,54	11-23-287/154
1,56	11-23-287/156
1,58	11-23-287/158
1,60	11-23-287/160
1,62	11-23-287/162
1,64	11-23-287/164
1,66	11-23-287/166
1,68	11-23-287/168
1,70	11-23-287/170
1,72	11-23-287/172
1,74	11-23-287/174
1,76	11-23-287/176



combined handbag

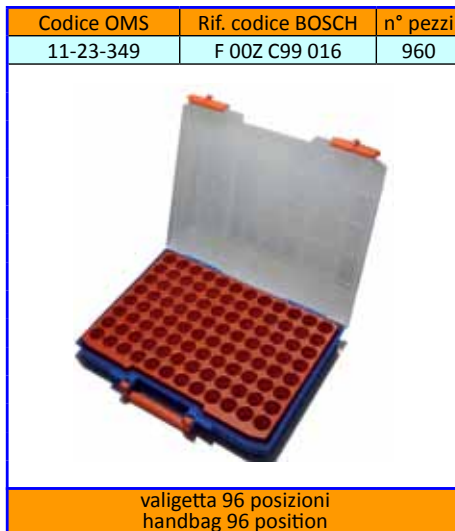
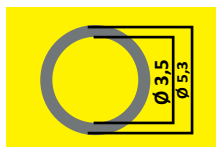
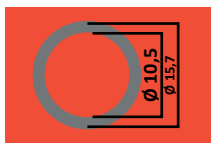

misura	rif. originale	cod. OMS
1,194	F 00V C10 402	11-23-219/1194
1,198	F 00V C10 404	11-23-219/1198
1,202	F 00V C10 406	11-23-219/1202
1,206	F 00V C10 408	11-23-219/1206
1,21	F 00V C10 410	11-23-219/121
1,214	F 00V C10 412	11-23-219/1214
1,218	F 00V C10 414	11-23-219/1218
1,222	F 00V C10 416	11-23-219/1222
1,226	F 00V C10 418	11-23-219/1226
1,23	F 00V C10 420	11-23-219/123
1,234	F 00V C10 422	11-23-219/1234
1,238	F 00V C10 424	11-23-219/1238
1,242	F 00V C10 426	11-23-219/1242
1,246	F 00V C10 428	11-23-219/1246
1,25	F 00V C10 430	11-23-219/125
1,254	F 00V C10 432	11-23-219/1254
1,258	F 00V C10 434	11-23-219/1258
1,262	F 00V C10 436	11-23-219/1262
1,266	F 00V C10 438	11-23-219/1266
1,27	F 00V C10 440	11-23-219/127
1,274	F 00V C10 442	11-23-219/1274
1,278	F 00V C10 444	11-23-219/1278
1,282	F 00V C10 446	11-23-219/1282
1,286	F 00V C10 448	11-23-219/1286

misura	rif. originale 1	rif. originale 2	cod. OMS
1,10	F 00V C10 470	F 00V C10 580	11-23-220/110
1,12	F 00V C10 472	F 00V C10 582	11-23-220/112
1,14	F 00V C10 474	F 00V C10 584	11-23-220/114
1,16	F 00V C10 476	F 00V C10 586	11-23-220/116
1,18	F 00V C10 478	F 00V C10 588	11-23-220/118
1,20	F 00V C10 480	F 00V C10 590	11-23-220/120
1,22	F 00V C10 482	F 00V C10 592	11-23-220/122
1,24	F 00V C10 484	F 00V C10 594	11-23-220/124
1,26	F 00V C10 486	F 00V C10 596	11-23-220/126
1,28	F 00V C10 488	F 00V C10 598	11-23-220/128
1,30	F 00V C10 490	F 00V C10 600	11-23-220/130
1,32	F 00V C10 492	F 00V C10 602	11-23-220/132
1,34	F 00V C10 494	F 00V C10 604	11-23-220/134
1,36	F 00V C10 496	F 00V C10 606	11-23-220/136
1,38	F 00V C10 498	F 00V C10 608	11-23-220/138
1,40	F 00V C10 500	F 00V C10 610	11-23-220/140
1,42	F 00V C10 502	F 00V C10 612	11-23-220/142
1,44	F 00V C10 504	F 00V C10 614	11-23-220/144
1,46	F 00V C10 506	F 00V C10 616	11-23-220/146
1,48	F 00V C10 508	F 00V C10 618	11-23-220/148
1,50	F 00V C10 510	F 00V C10 620	11-23-220/150
1,52	F 00V C10 512	F 00V C10 622	11-23-220/152
1,54	F 00V C10 514	F 00V C10 624	11-23-220/154
1,56	F 00V C10 516	F 00V C10 626	11-23-220/156
1,58	F 00V C10 518	F 00V C10 628	11-23-220/158
1,60	F 00V C10 520	F 00V C10 630	11-23-220/160
1,62	F 00V C10 522	F 00V C10 632	11-23-220/162
1,64	F 00V C10 524	F 00V C10 634	11-23-220/164
1,66	F 00V C10 526	F 00V C10 636	11-23-220/166
1,68	F 00V C10 528	F 00V C10 638	11-23-220/168
1,70	F 00V C10 530	F 00V C10 640	11-23-220/170
1,72	F 00V C10 532	F 00V C10 642	11-23-220/172
1,74	F 00V C10 534	F 00V C10 644	11-23-220/174
1,76	F 00V C10 536	F 00V C10 646	11-23-220/176
1,78	F 00V C10 538	F 00V C10 648	11-23-220/178
1,80	F 00V C10 540	F 00V C10 650	11-23-220/180

misura	cod. OMS
1,02	11-23-232/102
1,03	11-23-232/103
1,04	11-23-232/104
1,05	11-23-232/105
1,06	11-23-232/106
1,07	11-23-232/107
1,08	11-23-232/108
1,09	11-23-232/109
1,10	11-23-232/110
1,11	11-23-232/111
1,12	11-23-232/112
1,13	11-23-232/113
1,14	11-23-232/114
1,15	11-23-232/115
1,16	11-23-232/116
1,17	11-23-232/117
1,18	11-23-232/118
1,19	11-23-232/119
1,20	11-23-232/120
1,21	11-23-232/121
1,22	11-23-232/122
1,23	11-23-232/123
1,24	11-23-232/124
1,25	11-23-232/125

misura	rif. originale	cod. OMS
8,409	F 00V C12 444	11-23-227/8409
8,421	F 00V C12 448	11-23-227/8421
8,433	F 00V C12 452	11-23-227/8433
8,445	F 00V C12 456	11-23-227/8445
8,457	F 00V C12 460	11-23-227/8457
8,469	F 00V C12 464	11-23-227/8469
8,481	F 00V C12 468	11-23-227/8481
8,493	F 00V C12 472	11-23-227/8493
8,505	F 00V C12 476	11-23-227/8505
8,517	F 00V C12 480	11-23-227/8517
8,529	F 00V C12 484	11-23-227/8529
8,541	F 00V C12 488	11-23-227/8541



combined handbag OMS version

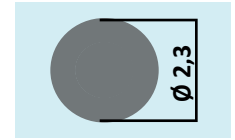
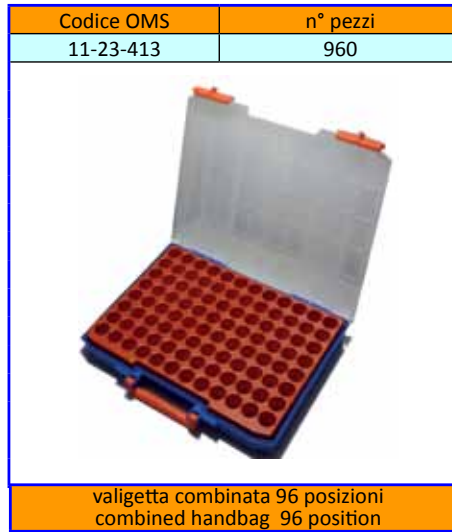
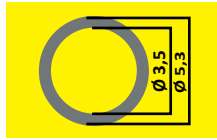

COMMON RAIL E DIESEL INJECTION SPARE PARTS oms@omsnet.it - www.omsnet.it



misura	cod. OMS
1,10	11-23-219-110
1,11	11-23-219-111
1,12	11-23-219-112
1,13	11-23-219-113
1,14	11-23-219-114
1,15	11-23-219-115
1,16	11-23-219-116
1,17	11-23-219-117
1,18	11-23-219-118
1,19	11-23-219-119
1,20	11-23-219-120
1,21	11-23-219-121
1,22	11-23-219-122
1,23	11-23-219-123
1,24	11-23-219-124
1,25	11-23-219-125
1,26	11-23-219-126
1,27	11-23-219-127
1,28	11-23-219-128
1,29	11-23-219-129
1,30	11-23-219-130
1,31	11-23-219-131
1,32	11-23-219-132
1,33	11-23-219-133

misura	ref. originale 1	ref. originale 2	cod. OMS
1,10	F 00V C10 470	F 00V C10 580	11-23-220/110
1,12	F 00V C10 472	F 00V C10 582	11-23-220/112
1,14	F 00V C10 474	F 00V C10 584	11-23-220/114
1,16	F 00V C10 476	F 00V C10 586	11-23-220/116
1,18	F 00V C10 478	F 00V C10 588	11-23-220/118
1,20	F 00V C10 480	F 00V C10 590	11-23-220/120
1,22	F 00V C10 482	F 00V C10 592	11-23-220/122
1,24	F 00V C10 484	F 00V C10 594	11-23-220/124
1,26	F 00V C10 486	F 00V C10 596	11-23-220/126
1,28	F 00V C10 488	F 00V C10 598	11-23-220/128
1,30	F 00V C10 490	F 00V C10 600	11-23-220/130
1,32	F 00V C10 492	F 00V C10 602	11-23-220/132
1,34	F 00V C10 494	F 00V C10 604	11-23-220/134
1,36	F 00V C10 496	F 00V C10 606	11-23-220/136
1,38	F 00V C10 498	F 00V C10 608	11-23-220/138
1,40	F 00V C10 500	F 00V C10 610	11-23-220/140
1,42	F 00V C10 502	F 00V C10 612	11-23-220/142
1,44	F 00V C10 504	F 00V C10 614	11-23-220/144
1,46	F 00V C10 506	F 00V C10 616	11-23-220/146
1,48	F 00V C10 508	F 00V C10 618	11-23-220/148
1,50	F 00V C10 510	F 00V C10 620	11-23-220/150
1,52	F 00V C10 512	F 00V C10 622	11-23-220/152
1,54	F 00V C10 514	F 00V C10 624	11-23-220/154
1,56	F 00V C10 516	F 00V C10 626	11-23-220/156
1,58	F 00V C10 518	F 00V C10 628	11-23-220/158
1,60	F 00V C10 520	F 00V C10 630	11-23-220/160
1,62	F 00V C10 522	F 00V C10 632	11-23-220/162
1,64	F 00V C10 524	F 00V C10 634	11-23-220/164
1,66	F 00V C10 526	F 00V C10 636	11-23-220/166
1,68	F 00V C10 528	F 00V C10 638	11-23-220/168
1,70	F 00V C10 530	F 00V C10 640	11-23-220/170
1,72	F 00V C10 532	F 00V C10 642	11-23-220/172
1,74	F 00V C10 534	F 00V C10 644	11-23-220/174
1,76	F 00V C10 536	F 00V C10 646	11-23-220/176
1,78	F 00V C10 538	F 00V C10 648	11-23-220/178
1,80	F 00V C10 540	F 00V C10 650	11-23-220/180

misura	cod. OMS
1,02	11-23-232/102
1,03	11-23-232/103
1,04	11-23-232/104
1,05	11-23-232/105
1,06	11-23-232/106
1,07	11-23-232/107
1,08	11-23-232/108
1,09	11-23-232/109
1,10	11-23-232/110
1,11	11-23-232/111
1,12	11-23-232/112
1,13	11-23-232/113
1,14	11-23-232/114
1,15	11-23-232/115
1,16	11-23-232/116
1,17	11-23-232/117
1,18	11-23-232/118
1,19	11-23-232/119
1,20	11-23-232/120
1,21	11-23-232/121
1,22	11-23-232/122
1,23	11-23-232/123
1,24	11-23-232/124
1,25	11-23-232/125

misura	ref. originale	cod. OMS
8,409	F 00V C12 444	11-23-227/8409
8,421	F 00V C12 448	11-23-227/8421
8,433	F 00V C12 452	11-23-227/8433
8,445	F 00V C12 456	11-23-227/8445
8,457	F 00V C12 460	11-23-227/8457
8,469	F 00V C12 464	11-23-227/8469
8,481	F 00V C12 468	11-23-227/8481
8,493	F 00V C12 472	11-23-227/8493
8,505	F 00V C12 476	11-23-227/8505
8,517	F 00V C12 480	11-23-227/8517
8,529	F 00V C12 484	11-23-227/8529
8,541	F 00V C12 488	11-23-227/8541



BOSCH

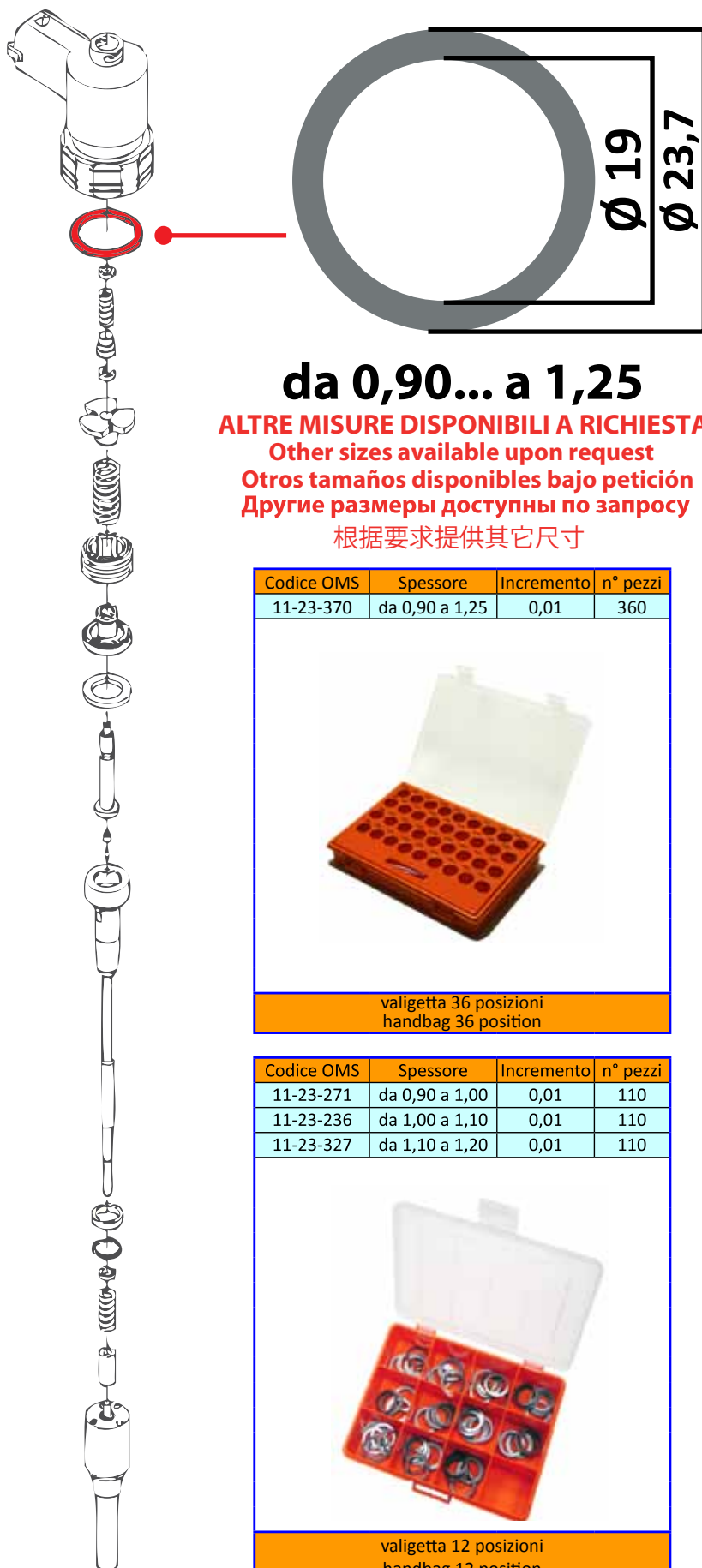

da 0,90... a 1,25

ALTRE MISURE DISPONIBILI A RICHIESTA

Other sizes available upon request

Otros tamaños disponibles bajo petición

Другие размеры доступны по запросу

根据要求提供其它尺寸

Codice OMS	Spessore	Incremento	n° pezzi
11-23-370	da 0,90 a 1,25	0,01	360



valigetta 36 posizioni
handbag 36 position

Codice OMS	Spessore	Incremento	n° pezzi
11-23-271	da 0,90 a 1,00	0,01	110
11-23-236	da 1,00 a 1,10	0,01	110
11-23-327	da 1,10 a 1,20	0,01	110



valigetta 12 posizioni
handbag 12 position

codice singoli spessori
code individual thicknesses
cada código de espesores

misura	cod. OMS
0,90	11-23-236/090
0,91	11-23-236/091
0,92	11-23-236/092
0,93	11-23-236/093
0,94	11-23-236/094
0,95	11-23-236/095
0,96	11-23-236/096
0,97	11-23-236/097
0,98	11-23-236/098
0,99	11-23-236/099
1,00	11-23-236/100
1,01	11-23-236/101
1,02	11-23-236/102
1,03	11-23-236/103
1,04	11-23-236/104
1,05	11-23-236/105
1,06	11-23-236/106
1,07	11-23-236/107
1,08	11-23-236/108
1,09	11-23-236/109
1,10	11-23-236/110
1,11	11-23-236/111
1,12	11-23-236/112
1,13	11-23-236/113
1,14	11-23-236/114
1,15	11-23-236/115
1,16	11-23-236/116
1,17	11-23-236/117
1,18	11-23-236/118
1,19	11-23-236/119
1,20	11-23-236/120
1,21	11-23-236/121
1,22	11-23-236/122
1,23	11-23-236/123
1,24	11-23-236/124
1,25	11-23-236/125



BOSCH

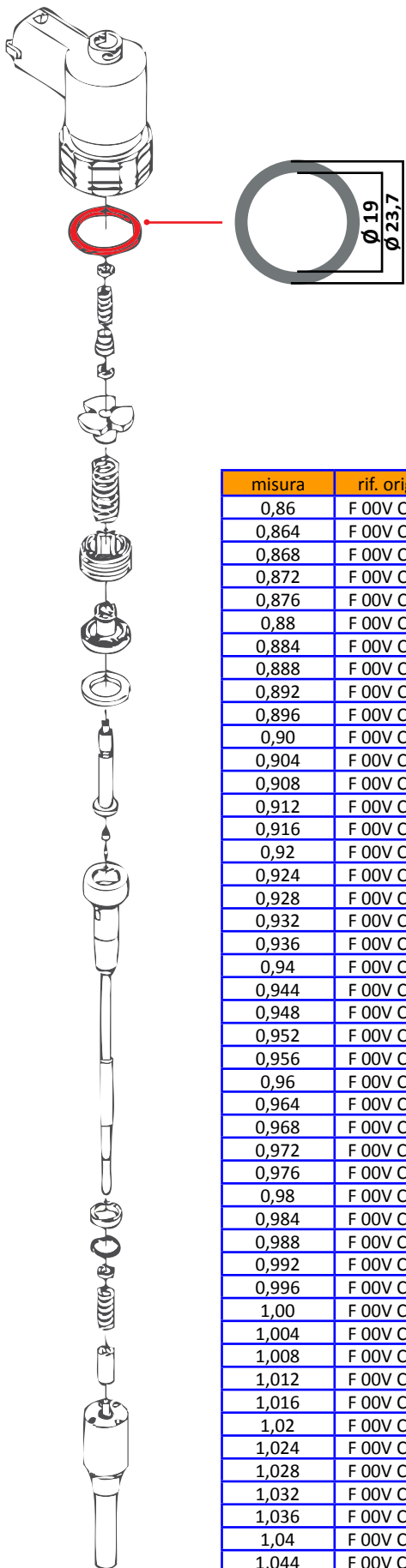

Codice OMS	Spessore	Incremento	n° pezzi
11-23-350	da 0,86 a 1,24	0,004	960



valigetta 96 posizioni
handbag 96 position

TABELLE CODICI ORIGINALI

misura	rif. originale	cod. OMS
0,86	F 00V C60 175	11-23-236/086
0,864	F 00V C60 177	11-23-236/0864
0,868	F 00V C60 179	11-23-236/0868
0,872	F 00V C60 181	11-23-236/0872
0,876	F 00V C60 183	11-23-236/0876
0,88	F 00V C60 185	11-23-236/088
0,884	F 00V C60 187	11-23-236/0884
0,888	F 00V C60 189	11-23-236/0888
0,892	F 00V C60 191	11-23-236/0892
0,896	F 00V C60 193	11-23-236/0896
0,90	F 00V C60 195	11-23-236/090
0,904	F 00V C60 197	11-23-236/0904
0,908	F 00V C60 199	11-23-236/0908
0,912	F 00V C60 201	11-23-236/0912
0,916	F 00V C60 203	11-23-236/0916
0,92	F 00V C60 205	11-23-236/092
0,924	F 00V C60 207	11-23-236/0924
0,928	F 00V C60 209	11-23-236/0928
0,932	F 00V C60 211	11-23-236/0932
0,936	F 00V C60 213	11-23-236/0936
0,94	F 00V C60 215	11-23-236/094
0,944	F 00V C60 217	11-23-236/0944
0,948	F 00V C60 219	11-23-236/0948
0,952	F 00V C60 221	11-23-236/0952
0,956	F 00V C60 223	11-23-236/0956
0,96	F 00V C60 225	11-23-236/096
0,964	F 00V C60 227	11-23-236/0964
0,968	F 00V C60 229	11-23-236/0968
0,972	F 00V C60 231	11-23-236/0972
0,976	F 00V C60 233	11-23-236/0976
0,98	F 00V C60 235	11-23-236/098
0,984	F 00V C60 237	11-23-236/0984
0,988	F 00V C60 239	11-23-236/0988
0,992	F 00V C60 241	11-23-236/0992
0,996	F 00V C60 243	11-23-236/0996
1,00	F 00V C60 245	11-23-236/100
1,004	F 00V C60 247	11-23-236/1004
1,008	F 00V C60 249	11-23-236/1008
1,012	F 00V C60 251	11-23-236/1012
1,016	F 00V C60 253	11-23-236/1016
1,02	F 00V C60 255	11-23-236/102
1,024	F 00V C60 257	11-23-236/1024
1,028	F 00V C60 259	11-23-236/1028
1,032	F 00V C60 261	11-23-236/1032
1,036	F 00V C60 263	11-23-236/1036
1,04	F 00V C60 265	11-23-236/104
1,044	F 00V C60 267	11-23-236/1044
1,048	F 00V C60 269	11-23-236/1048

misura	rif. originale	cod. OMS
1,052	F 00V C60 271	11-23-236/1052
1,056	F 00V C60 273	11-23-236/1056
1,06	F 00V C60 275	11-23-236/106
1,064	F 00V C60 277	11-23-236/1064
1,068	F 00V C60 279	11-23-236/1068
1,072	F 00V C60 281	11-23-236/1072
1,076	F 00V C60 283	11-23-236/1076
1,08	F 00V C60 285	11-23-236/108
1,084	F 00V C60 287	11-23-236/1084
1,088	F 00V C60 289	11-23-236/1088
1,092	F 00V C60 291	11-23-236/1092
1,096	F 00V C60 293	11-23-236/1096
1,10	F 00V C60 295	11-23-236/110
1,104	F 00V C60 297	11-23-236/1104
1,108	F 00V C60 299	11-23-236/1108
1,112	F 00V C60 301	11-23-236/1112
1,116	F 00V C60 303	11-23-236/1116
1,12	F 00V C60 305	11-23-236/112
1,124	F 00V C60 307	11-23-236/1124
1,128	F 00V C60 309	11-23-236/1128
1,132	F 00V C60 311	11-23-236/1132
1,136	F 00V C60 313	11-23-236/1136
1,14	F 00V C60 315	11-23-236/114
1,144	F 00V C60 317	11-23-236/1144
1,148	F 00V C60 319	11-23-236/1148
1,152	F 00V C60 321	11-23-236/1152
1,156	F 00V C60 323	11-23-236/1156
1,16	F 00V C60 325	11-23-236/116
1,164	F 00V C60 327	11-23-236/1164
1,168	F 00V C60 329	11-23-236/1168
1,172	F 00V C60 331	11-23-236/1172
1,176	F 00V C60 333	11-23-236/1176
1,18	F 00V C60 335	11-23-236/118
1,184	F 00V C60 337	11-23-236/1184
1,188	F 00V C60 339	11-23-236/1188
1,192	F 00V C60 341	11-23-236/1192
1,196	F 00V C60 343	11-23-236/1196
1,20	F 00V C60 345	11-23-236/120
1,204	F 00V C60 347	11-23-236/1204
1,208	F 00V C60 349	11-23-236/1208
1,212	F 00V C60 351	11-23-236/1212
1,216	F 00V C60 353	11-23-236/1216
1,22	F 00V C60 355	11-23-236/122
1,224	F 00V C60 357	11-23-236/1224
1,228	F 00V C60 359	11-23-236/1228
1,232	F 00V C60 361	11-23-236/1232
1,236	F 00V C60 363	11-23-236/1236
1,24	F 00V C60 365	11-23-236/124



BOSCH

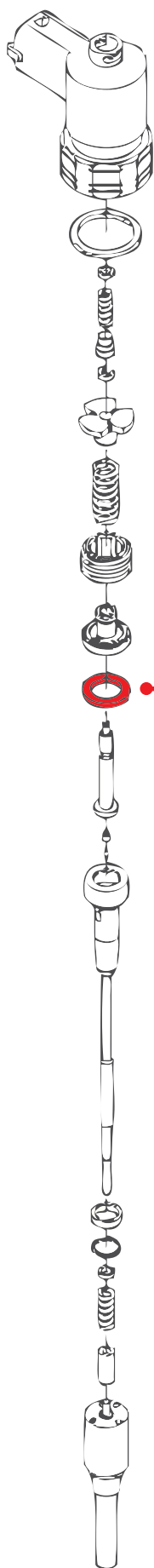

da 1,00 ... a 1,33

ALTRE MISURE DISPONIBILI A RICHIESTA

Other sizes available upon request

Otros tamaños disponibles bajo petición

Другие размеры доступны по запросу

根据要求提供其它尺寸

Codice OMS	Spessore	Incremento	n° pezzi
11-23-285	da 1,10 a 1,20	0,01	110
11-23-219	da 1,20 a 1,30	0,01	110



valigetta 12 posizioni
handbag 12 position

Codice OMS	Spessore	Incremento	n° pezzi
11-23-371	da 1,10 a 1,33	0,01	240



valigetta 24 posizioni
handbag 24 position

Codice OMS	Spessore	Incremento	n° pezzi
11-23-372	da 1,10 a 1,33	0,01	340



valigetta 36 posizioni
handbag 36 position

codice singoli spessori
code individual
thicknesses

misura	cod. OMS
1,00	11-23-219/100
1,01	11-23-219/101
1,02	11-23-219/102
1,03	11-23-219/103
1,04	11-23-219/104
1,05	11-23-219/105
1,06	11-23-219/106
1,07	11-23-219/107
1,08	11-23-219/108
1,09	11-23-219/109
1,10	11-23-219/110
1,11	11-23-219/111
1,12	11-23-219/112
1,13	11-23-219/113
1,14	11-23-219/114
1,15	11-23-219/115
1,16	11-23-219/116
1,17	11-23-219/117
1,18	11-23-219/118
1,19	11-23-219/119
1,20	11-23-219/120
1,21	11-23-219/121
1,22	11-23-219/122
1,23	11-23-219/123
1,24	11-23-219/124
1,25	11-23-219/125
1,26	11-23-219/126
1,27	11-23-219/127
1,28	11-23-219/128
1,29	11-23-219/129
1,30	11-23-219/130
1,31	11-23-219/131
1,32	11-23-219/132
1,33	11-23-219/133



BOSCH



TABELLA CODICI ORIGINALI
INCREMENTO: 0,004

Codice OMS	Spessore	Incremento	n° pezzi
11-23-373	da 1,19 a 1,33	0,004	360

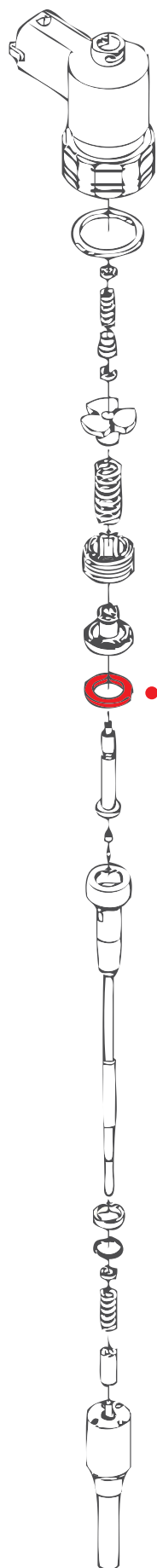

valigetta 36 posizioni
handbag 36 position

TABELLA CODICI ORIGINALI

misura	ref. originale	cod. OMS
1,19	F 00V C10 400	11-23-219/119
1,194	F 00V C10 402	11-23-219/1194
1,198	F 00V C10 404	11-23-219/1198
1,202	F 00V C10 406	11-23-219/1202
1,206	F 00V C10 408	11-23-219/1206
1,21	F 00V C10 410	11-23-219/121
1,214	F 00V C10 412	11-23-219/1214
1,218	F 00V C10 414	11-23-219/1218
1,222	F 00V C10 416	11-23-219/1222
1,226	F 00V C10 418	11-23-219/1226
1,23	F 00V C10 420	11-23-219/123
1,234	F 00V C10 422	11-23-219/1234
1,238	F 00V C10 424	11-23-219/1238
1,242	F 00V C10 426	11-23-219/1242
1,246	F 00V C10 428	11-23-219/1246
1,25	F 00V C10 430	11-23-219/125
1,254	F 00V C10 432	11-23-219/1254
1,258	F 00V C10 434	11-23-219/1258
1,262	F 00V C10 436	11-23-219/1262
1,266	F 00V C10 438	11-23-219/1266
1,27	F 00V C10 440	11-23-219/127
1,274	F 00V C10 442	11-23-219/1274
1,278	F 00V C10 444	11-23-219/1278
1,282	F 00V C10 446	11-23-219/1282
1,286	F 00V C10 448	11-23-219/1286
1,29	F 00V C10 450	11-23-219/129
1,294	F 00V C10 452	11-23-219/1294
1,298		11-23-219/1298
1,302		11-23-219/1302
1,306		11-23-219/1306
1,310		11-23-219/460
1,314		11-23-219/1314
1,318		11-23-219/1318
1,322		11-23-219/1322
1,326		11-23-219/1326
1,330		11-23-219/1330



BOSCH

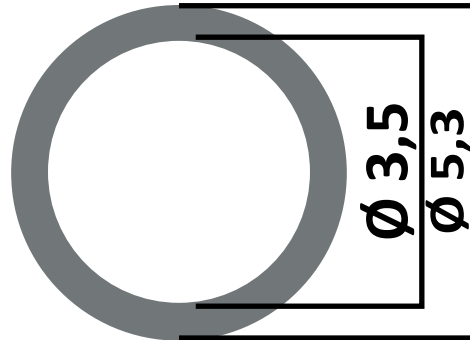

da 0,90 ... a 2,00

ALTRE MISURE DISPONIBILI A RICHIESTA
Other sizes available upon request
Otros tamaños disponibles bajo petición
Другие размеры доступны по запросу
根据要求提供其它尺寸

Codice OMS	Spessore	Incremento	n° pezzi
11-23-244	da 1,20 a 1,70	0,05	110



valigetta 12 posizioni
handbag 12 position

Codice OMS	Spessore	Incremento	n° pezzi
11-23-269	da 0,90 a 1,90	0,05	210
11-23-220	da 1,20 a 1,70	0,02	240
11-23-264	da 1,40 a 1,86	0,02	240



valigetta 24 posizioni
handbag 24 position

codice singoli spessori
code individual thicknesses

misura	cod. OMS
0,90	11-23-220/090
0,95	11-23-220/095
1,00	11-23-220/100
1,05	11-23-220/105
1,10	11-23-220/110
1,15	11-23-220/115
1,20	11-23-220/120
1,22	11-23-220/122
1,24	11-23-220/124
1,25	11-23-220/125
1,26	11-23-220/126
1,28	11-23-220/128
1,30	11-23-220/130
1,32	11-23-220/132
1,34	11-23-220/134
1,35	11-23-220/135
1,36	11-23-220/136
1,38	11-23-220/138
1,40	11-23-220/140
1,42	11-23-220/142
1,44	11-23-220/144
1,45	11-23-220/145
1,46	11-23-220/146
1,48	11-23-220/148
1,50	11-23-220/150
1,52	11-23-220/152
1,54	11-23-220/154
1,55	11-23-220/155
1,56	11-23-220/156
1,58	11-23-220/158
1,60	11-23-220/160
1,62	11-23-220/162
1,64	11-23-220/164
1,65	11-23-220/165
1,66	11-23-220/166
1,68	11-23-220/168
1,70	11-23-220/170
1,72	11-23-220/172
1,74	11-23-220/174
1,75	11-23-220/175
1,76	11-23-220/176
1,78	11-23-220/178
1,80	11-23-220/180
1,82	11-23-220/182
1,84	11-23-220/184
1,85	11-23-220/185
1,86	11-23-220/186
1,90	11-23-220/190
1,95	11-23-220/195
2,00	11-23-220/200



BOSCH



TABELLA CODICI ORIGINALI

misura	rif. originale 1	rif. originale 2	cod. OMS
1,00	F 00V C10 460	F 00V C10 570	11-23-220/100
1,02	F 00V C10 462	F 00V C10 572	11-23-220/102
1,04	F 00V C10 464	F 00V C10 574	11-23-220/104
1,06	F 00V C10 466	F 00V C10 576	11-23-220/106
1,08	F 00V C10 468	F 00V C10 578	11-23-220/108
1,10	F 00V C10 470	F 00V C10 580	11-23-220/110
1,12	F 00V C10 472	F 00V C10 582	11-23-220/112
1,14	F 00V C10 474	F 00V C10 584	11-23-220/114
1,16	F 00V C10 476	F 00V C10 586	11-23-220/116
1,18	F 00V C10 478	F 00V C10 588	11-23-220/118
1,20	F 00V C10 480	F 00V C10 590	11-23-220/120
1,22	F 00V C10 482	F 00V C10 592	11-23-220/122
1,24	F 00V C10 484	F 00V C10 594	11-23-220/124
1,26	F 00V C10 486	F 00V C10 596	11-23-220/126
1,28	F 00V C10 488	F 00V C10 598	11-23-220/128
1,30	F 00V C10 490	F 00V C10 600	11-23-220/130
1,32	F 00V C10 492	F 00V C10 602	11-23-220/132
1,34	F 00V C10 494	F 00V C10 604	11-23-220/134
1,36	F 00V C10 496	F 00V C10 606	11-23-220/136
1,38	F 00V C10 498	F 00V C10 608	11-23-220/138
1,40	F 00V C10 500	F 00V C10 610	11-23-220/140
1,42	F 00V C10 502	F 00V C10 612	11-23-220/142
1,44	F 00V C10 504	F 00V C10 614	11-23-220/144
1,46	F 00V C10 506	F 00V C10 616	11-23-220/146
1,48	F 00V C10 508	F 00V C10 618	11-23-220/148
1,50	F 00V C10 510	F 00V C10 620	11-23-220/150
1,52	F 00V C10 512	F 00V C10 622	11-23-220/152
1,54	F 00V C10 514	F 00V C10 624	11-23-220/154
1,56	F 00V C10 516	F 00V C10 626	11-23-220/156
1,58	F 00V C10 518	F 00V C10 628	11-23-220/158
1,60	F 00V C10 520	F 00V C10 630	11-23-220/160
1,62	F 00V C10 522	F 00V C10 632	11-23-220/162
1,64	F 00V C10 524	F 00V C10 634	11-23-220/164
1,66	F 00V C10 526	F 00V C10 636	11-23-220/166
1,68	F 00V C10 528	F 00V C10 638	11-23-220/168
1,70	F 00V C10 530	F 00V C10 640	11-23-220/170
1,72	F 00V C10 532	F 00V C10 642	11-23-220/172
1,74	F 00V C10 534	F 00V C10 644	11-23-220/174
1,76	F 00V C10 536	F 00V C10 646	11-23-220/176
1,78	F 00V C10 538	F 00V C10 648	11-23-220/178
1,80	F 00V C10 540	F 00V C10 650	11-23-220/180
1,82	F 00V C10 542	F 00V C10 652	11-23-220/182
1,84	F 00V C10 544	F 00V C10 654	11-23-220/184
1,86	F 00V C10 546	F 00V C10 656	11-23-220/186
1,88	F 00V C10 548	F 00V C10 658	11-23-220/188
1,90	F 00V C10 550	F 00V C10 660	11-23-220/190
1,92	F 00V C10 552	F 00V C10 662	11-23-220/192
1,94	F 00V C10 554	F 00V C10 664	11-23-220/194
1,96	F 00V C10 556	F 00V C10 666	11-23-220/196
1,98	F 00V C10 558	F 00V C10 668	11-23-220/198
2,00	F 00V C10 560	F 00V C10 670	11-23-220/200

Codice OMS	Spessore	Incremento	n° pezzi
11-23-374	da 1,00 a 2,00	0,02	510

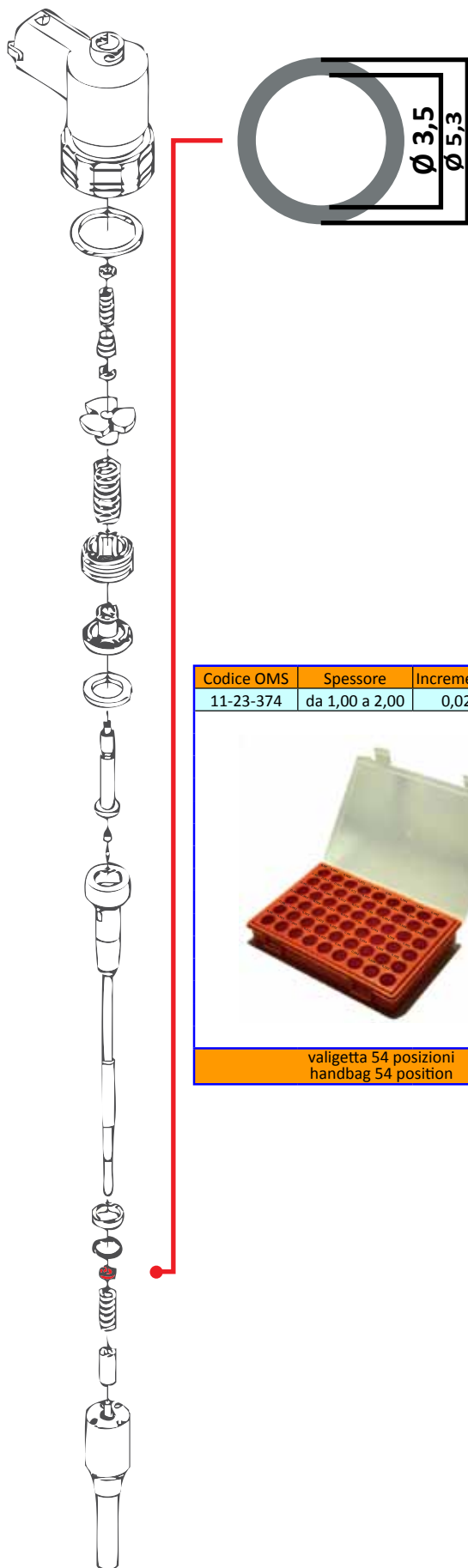

valigetta 54 posizioni
handbag 54 position



BOSCH



da 1,00.. a 1,86

ALTRE MISURE DISPONIBILI A RICHIESTA

Other sizes available upon request

Otros tamaños disponibles bajo petición

Другие размеры доступны по запросу

根据要求提供其它尺寸

Codice OMS	Spessore	Incremento	n° pezzi
11-23-334	da 1,00 a 1,20	0,02	110



valigetta 12 posizioni
handbag 12 position

Codice OMS	Spessore	Incremento	n° pezzi
11-23-330	da 1,60 a 1,86	0,02	140



valigetta 24 posizioni
handbag 24 position

codice singoli spessori
code individual thicknesses

misura	cod. OMS
1,00	11-23-330/100
1,02	11-23-330/102
1,04	11-23-330/104
1,06	11-23-330/106
1,08	11-23-330/108
1,10	11-23-330/110
1,12	11-23-330/112
1,14	11-23-330/114
1,16	11-23-330/116
1,18	11-23-330/118
1,20	11-23-330/120
1,40	11-23-330/122
1,60	11-23-330/160
1,62	11-23-330/162
1,64	11-23-330/164
1,66	11-23-330/166
1,68	11-23-330/168
1,70	11-23-330/170
1,72	11-23-330/172
1,74	11-23-330/174
1,76	11-23-330/176
1,78	11-23-330/178
1,80	11-23-330/180
1,82	11-23-330/182
1,84	11-23-330/184
1,86	11-23-330/186



BOSCH

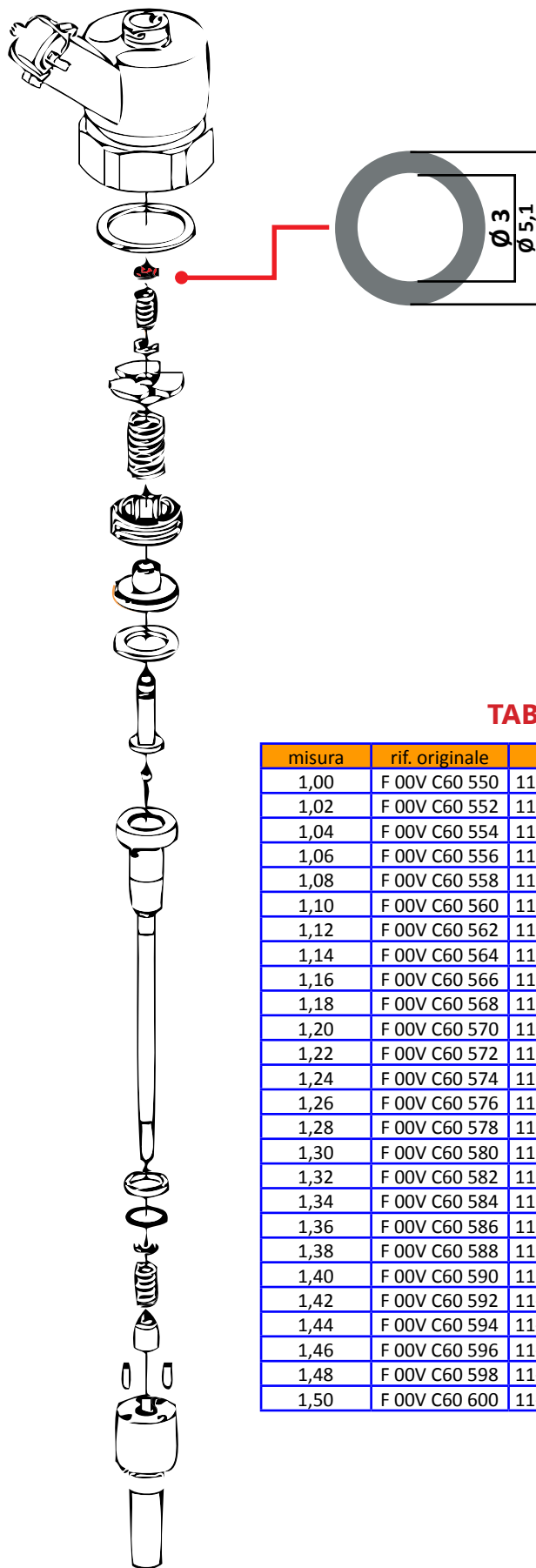

Codice OMS	Spessore	Incremento	n° pezzi
11-23-375	da 1,00 a 2,00	0,02	510



valigetta 54 posizioni
handbag 54 position

TABELLE CODICI ORIGINALI

misura	rif. originale	cod. OMS
1,00	F 00V C60 550	11-23-330/100
1,02	F 00V C60 552	11-23-330/102
1,04	F 00V C60 554	11-23-330/104
1,06	F 00V C60 556	11-23-330/106
1,08	F 00V C60 558	11-23-330/108
1,10	F 00V C60 560	11-23-330/110
1,12	F 00V C60 562	11-23-330/112
1,14	F 00V C60 564	11-23-330/114
1,16	F 00V C60 566	11-23-330/116
1,18	F 00V C60 568	11-23-330/118
1,20	F 00V C60 570	11-23-330/120
1,22	F 00V C60 572	11-23-330/122
1,24	F 00V C60 574	11-23-330/124
1,26	F 00V C60 576	11-23-330/126
1,28	F 00V C60 578	11-23-330/128
1,30	F 00V C60 580	11-23-330/130
1,32	F 00V C60 582	11-23-330/132
1,34	F 00V C60 584	11-23-330/134
1,36	F 00V C60 586	11-23-330/136
1,38	F 00V C60 588	11-23-330/138
1,40	F 00V C60 590	11-23-330/140
1,42	F 00V C60 592	11-23-330/142
1,44	F 00V C60 594	11-23-330/144
1,46	F 00V C60 596	11-23-330/146
1,48	F 00V C60 598	11-23-330/148
1,50	F 00V C60 600	11-23-330/150

misura	rif. originale	cod. OMS
1,52	F 00V C60 602	11-23-330/152
1,54	F 00V C60 604	11-23-330/154
1,56	F 00V C60 606	11-23-330/156
1,58	F 00V C60 608	11-23-330/158
1,60	F 00V C60 610	11-23-330/160
1,62	F 00V C60 612	11-23-330/162
1,64	F 00V C60 614	11-23-330/164
1,66	F 00V C60 616	11-23-330/166
1,68	F 00V C60 618	11-23-330/168
1,70	F 00V C60 620	11-23-330/170
1,72	F 00V C60 622	11-23-330/172
1,74	F 00V C60 624	11-23-330/174
1,76	F 00V C60 626	11-23-330/176
1,78	F 00V C60 628	11-23-330/178
1,80	F 00V C60 630	11-23-330/180
1,82	F 00V C60 632	11-23-330/182
1,84	F 00V C60 634	11-23-330/184
1,86	F 00V C60 636	11-23-330/186
1,88	F 00V C60 638	11-23-330/188
1,90	F 00V C60 640	11-23-330/190
1,92	F 00V C60 642	11-23-330/192
1,94	F 00V C60 644	11-23-330/194
1,96	F 00V C60 646	11-23-330/196
1,98	F 00V C60 648	11-23-330/198
2,00	F 00V C60 650	11-23-330/200



BOSCH

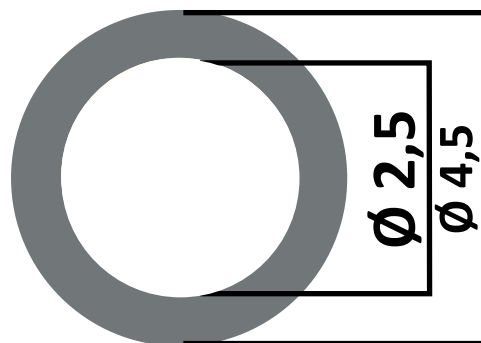
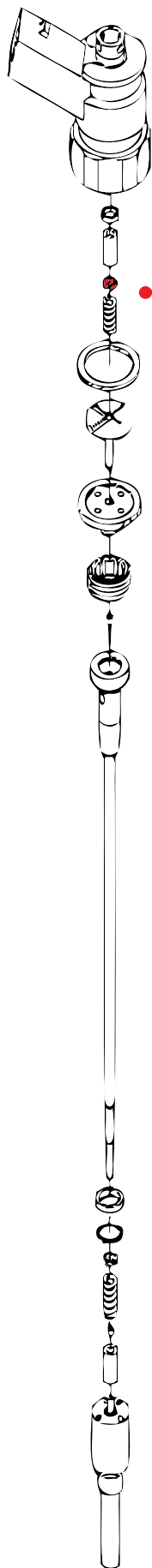

da 1,20.. a 1,86

ALTRE MISURE DISPONIBILI A RICHIESTA

Other sizes available upon request

Otros tamaños disponibles bajo petición

Другие размеры доступны по запросу

根据要求提供其它尺寸

Codice OMS	Spessore	Incremento	n° pezzi
11-23-245	da 1,20 a 1,70	0,05	110
11-23-263	da 1,64 a 1,86	0,02	120



valigetta 12 posizioni
handbag 12 position

Codice OMS	Spessore	Incremento	n° pezzi
11-23-230	da 1,20 a 1,70	0,02	240



valigetta 24 posizioni
handbag 24 position

codice singoli spessori
code individual thicknesses

misura	cod. OMS
1,20	11-23-230/120
1,22	11-23-230/122
1,24	11-23-230/124
1,25	11-23-230/125
1,26	11-23-230/126
1,28	11-23-230/128
1,30	11-23-230/130
1,32	11-23-230/132
1,34	11-23-230/134
1,35	11-23-230/135
1,36	11-23-230/136
1,38	11-23-230/138
1,40	11-23-230/140
1,42	11-23-230/142
1,44	11-23-230/144
1,45	11-23-230/145
1,46	11-23-230/146
1,48	11-23-230/148
1,50	11-23-230/150
1,52	11-23-230/152
1,54	11-23-230/154
1,55	11-23-230/155
1,56	11-23-230/156
1,58	11-23-230/158
1,60	11-23-230/160
1,62	11-23-230/162
1,64	11-23-230/164
1,65	11-23-230/165
1,66	11-23-230/166
1,68	11-23-230/168
1,70	11-23-230/170
1,72	11-23-230/172
1,74	11-23-230/174
1,76	11-23-230/176
1,78	11-23-230/178
1,80	11-23-230/180
1,82	11-23-230/182
1,84	11-23-230/184
1,86	11-23-230/186



BOSCH

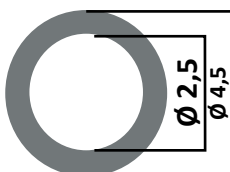
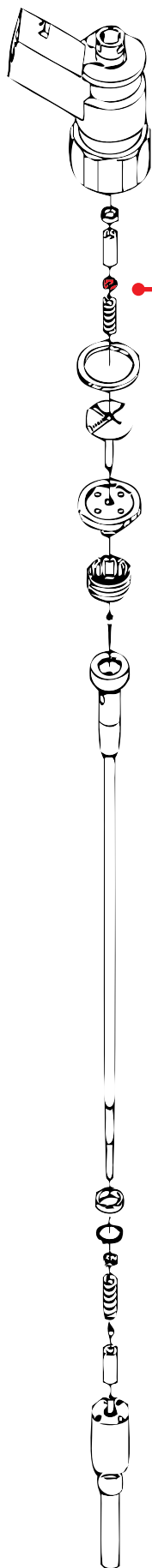

Codice OMS	Spessore	Incremento	n° pezzi
11-23-376	da 1,20 a 1,90	0,02	360



valigetta 36 posizioni
handbag 36 position

TABELLA CODICI ORIGINALI

misura	rif. originale	cod. OMS
1,20		11-23-230/120
1,22		11-23-230/122
1,24		11-23-230/124
1,26		11-23-230/126
1,28		11-23-230/128
1,30		11-23-230/130
1,32		11-23-230/132
1,34		11-23-230/134
1,36		11-23-230/136
1,38		11-23-230/138
1,40	F 00V C60 485	11-23-230/140
1,42	F 00V C60 487	11-23-230/142
1,44	F 00V C60 489	11-23-230/144
1,46	F 00V C60 491	11-23-230/146
1,48	F 00V C60 493	11-23-230/148
1,50	F 00V C60 495	11-23-230/150
1,52	F 00V C60 497	11-23-230/152
1,54	F 00V C60 499	11-23-230/154
1,56	F 00V C60 501	11-23-230/156
1,58	F 00V C60 503	11-23-230/158
1,60	F 00V C60 505	11-23-230/160
1,62	F 00V C60 507	11-23-230/162
1,64	F 00V C60 509	11-23-230/164
1,66	F 00V C60 511	11-23-230/166
1,68	F 00V C60 513	11-23-230/168
1,70	F 00V C60 515	11-23-230/170
1,72	F 00V C60 517	11-23-230/172
1,74	F 00V C60 519	11-23-230/174
1,76	F 00V C60 521	11-23-230/176
1,78	F 00V C60 523	11-23-230/178
1,80	F 00V C60 525	11-23-230/180
1,82	F 00V C60 527	11-23-230/182
1,84	F 00V C60 529	11-23-230/184
1,86	F 00V C60 531	11-23-230/186
1,88	F 00V C60 533	11-23-230/188
1,90	F 00V C60 535	11-23-230/190



BOSCH

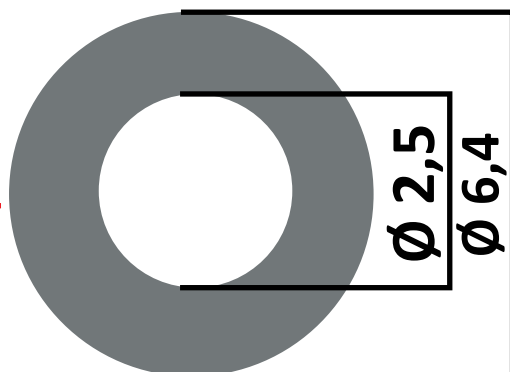
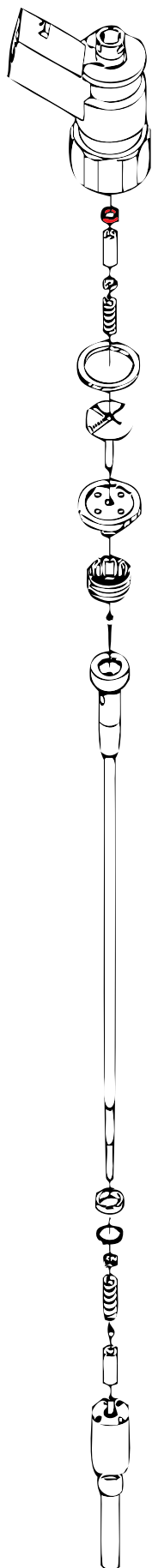

da 1,00... a 1,40

ALTRE MISURE DISPONIBILI A RICHIESTA
Other sizes available upon request
Otros tamaños disponibles bajo petición
Другие размеры доступны по запросу
根据要求提供其它尺寸

Codice OMS	Spessore	Incremento	n° pezzi
11-23-329	da 1,20 a 1,30	0,01	110



valigetta 12 posizioni
handbag 12 position

Codice OMS	Spessore	Incremento	n° pezzi
11-23-377	da 1,00 a 1,40	0,01	410



valigetta 54 posizioni
handbag 54 position

codice singoli spessori
code individual thicknesses

misura	cod. OMS
1,00	11-23-329/100
1,01	11-23-329/101
1,02	11-23-329/102
1,03	11-23-329/103
1,04	11-23-329/104
1,05	11-23-329/105
1,06	11-23-329/106
1,07	11-23-329/107
1,08	11-23-329/108
1,09	11-23-329/109
1,10	11-23-329/110
1,11	11-23-329/111
1,12	11-23-329/112
1,13	11-23-329/113
1,14	11-23-329/114
1,15	11-23-329/115
1,16	11-23-329/116
1,17	11-23-329/117
1,18	11-23-329/118
1,19	11-23-329/119
1,20	11-23-329/120
1,21	11-23-329/121
1,22	11-23-329/122
1,23	11-23-329/123
1,24	11-23-329/124
1,25	11-23-329/125
1,26	11-23-329/126
1,27	11-23-329/127
1,28	11-23-329/128
1,29	11-23-329/129
1,30	11-23-329/130
1,31	11-23-329/131
1,32	11-23-329/132
1,33	11-23-329/133
1,34	11-23-329/134
1,35	11-23-329/135
1,36	11-23-329/136
1,37	11-23-329/137
1,38	11-23-329/138
1,39	11-23-329/139
1,40	11-23-329/140



BOSCH



TABELLA CODICI ORIGINALI

misura	rif. originale	cod. OMS
1,089	F 00V C60 386	11-23-329/1089
1,098	F 00V C60 389	11-23-329/1098
1,107	F 00V C60 392	11-23-329/1107
1,116	F 00V C60 395	11-23-329/1116
1,125	F 00V C60 398	11-23-329/1125
1,134	F 00V C60 401	11-23-329/1134
1,143	F 00V C60 404	11-23-329/1143
1,152	F 00V C60 407	11-23-329/1152
1,161	F 00V C60 410	11-23-329/1161
1,17	F 00V C60 413	11-23-329/1170
1,179	F 00V C60 416	11-23-329/1179
1,188	F 00V C60 419	11-23-329/1188
1,197	F 00V C60 422	11-23-329/1197
1,206	F 00V C60 425	11-23-329/1206
1,215	F 00V C60 428	11-23-329/1215
1,224	F 00V C60 431	11-23-329/1224
1,233	F 00V C60 434	11-23-329/1233
1,242	F 00V C60 437	11-23-329/1242
1,251	F 00V C60 440	11-23-329/1251
1,26	F 00V C60 443	11-23-329/1260
1,269	F 00V C60 446	11-23-329/1269
1,278	F 00V C60 449	11-23-329/1278
1,287	F 00V C60 452	11-23-329/1287
1,296	F 00V C60 455	11-23-329/1296
1,305	F 00V C60 458	11-23-329/1305
1,314	F 00V C60 461	11-23-329/1314
1,323	F 00V C60 464	11-23-329/1323
1,332	F 00V C60 467	11-23-329/1332
1,341	F 00V C60 470	11-23-329/1341
1,35	F 00V C60 473	11-23-329/1350
1,359	F 00V C60 476	11-23-329/1359
1,368	F 00V C60 479	11-23-329/1368



BOSCH

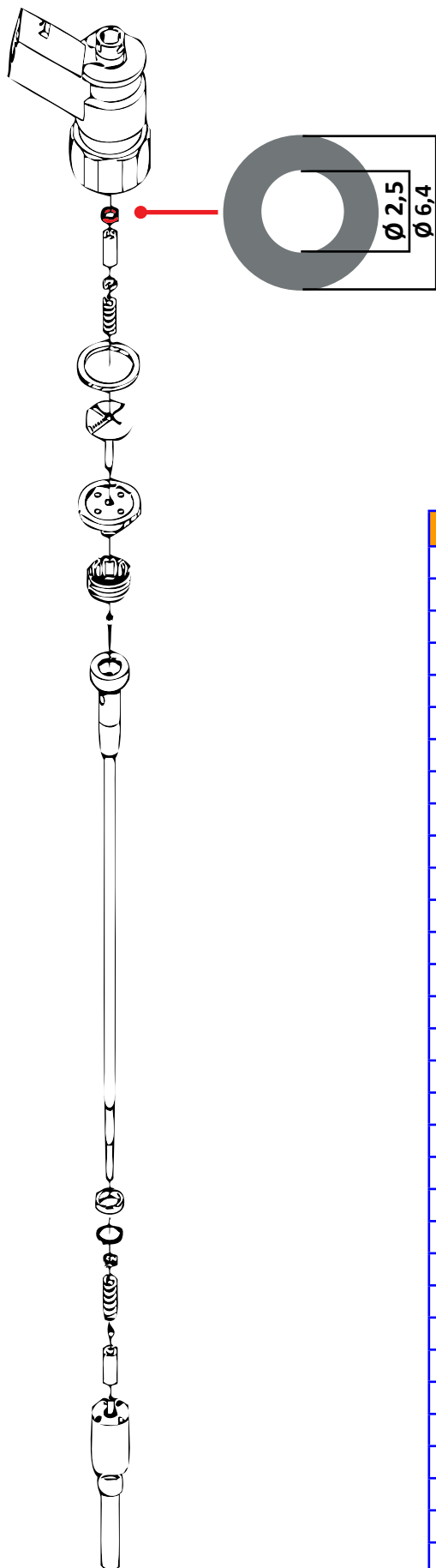
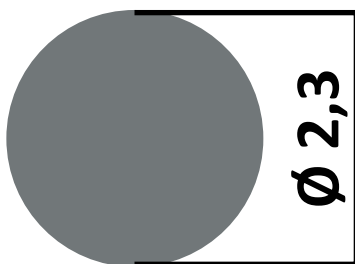
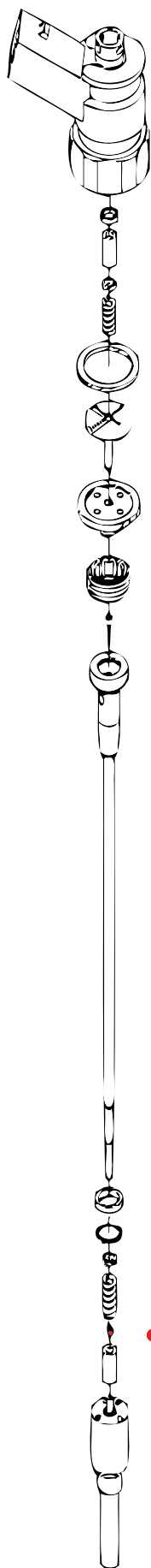

PASTIGLIETTA
tablet
tableta

da 0,90 ... a 1,40

ALTRE MISURE DISPONIBILI A RICHIESTA
Other sizes available upon request

Otros tamaños disponibles bajo petición

Другие размеры доступны по запросу

根据要求提供其它尺寸

Codice OMS	Spessore	Incremento	n° pezzi
11-23-305	da 0,90 a 1,01	0,01	120
11-23-306	da 1,02 a 1,13	0,01	120
11-23-232	da 1,14 a 1,25	0,01	120



valigetta 12 posizioni
handbag 12 position

Codice OMS	Spessore	Incremento	n° pezzi
11-23-283	da 0,95 a 1,13	0,01	190



valigetta 24 posizioni
handbag 24 position

codice singoli spessori
code individual thicknesses

misura	cod. OMS
0,90	11-23-232/090
0,91	11-23-232/091
0,92	11-23-232/092
0,93	11-23-232/093
0,94	11-23-232/094
0,95	11-23-232/095
0,96	11-23-232/096
0,97	11-23-232/097
0,98	11-23-232/098
0,99	11-23-232/099
1,00	11-23-232/100
1,01	11-23-232/101
1,02	11-23-232/102
1,03	11-23-232/103
1,04	11-23-232/104
1,05	11-23-232/105
1,06	11-23-232/106
1,07	11-23-232/107
1,08	11-23-232/108
1,09	11-23-232/109
1,10	11-23-232/110
1,11	11-23-232/111
1,12	11-23-232/112
1,13	11-23-232/113
1,14	11-23-232/114
1,15	11-23-232/115
1,16	11-23-232/116
1,17	11-23-232/117
1,18	11-23-232/118
1,19	11-23-232/119
1,20	11-23-232/120
1,21	11-23-232/121
1,22	11-23-232/122
1,23	11-23-232/123
1,24	11-23-232/124
1,25	11-23-232/125
1,26	11-23-232/126
1,27	11-23-232/127
1,28	11-23-232/128
1,29	11-23-232/129
1,30	11-23-232/130
1,31	11-23-232/131
1,32	11-23-232/132
1,33	11-23-232/133
1,34	11-23-232/134
1,35	11-23-232/135
1,36	11-23-232/136
1,37	11-23-232/137
1,38	11-23-232/138
1,39	11-23-232/139
1,40	11-23-232/140



BOSCH

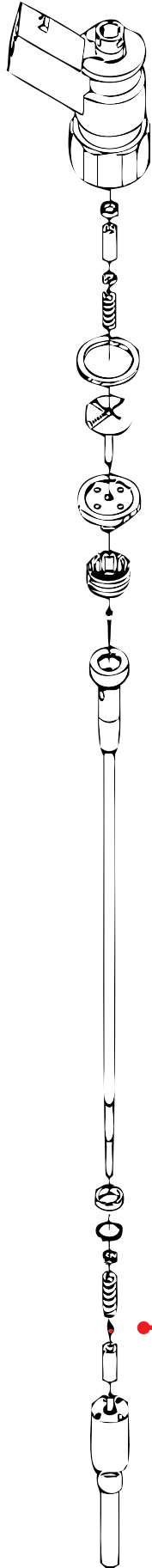

Codice OMS	Spessore	Incremento	n° pezzi
11-23-379	da 1,00 a 1,36	0,01	370



valigetta 54 posizioni
handbag 54 position

TABELLA CODICI ORIGINALI

misura	rif. originale	cod. OMS
1,00	F 00V C12 500	11-23-232/100
1,01	F 00V C12 502	11-23-232/101
1,02	F 00V C12 504	11-23-232/102
1,03	F 00V C12 506	11-23-232/103
1,04	F 00V C12 508	11-23-232/104
1,05	F 00V C12 510	11-23-232/105
1,06	F 00V C12 512	11-23-232/106
1,07	F 00V C12 514	11-23-232/107
1,08	F 00V C12 516	11-23-232/108
1,09	F 00V C12 518	11-23-232/109
1,10	F 00V C12 520	11-23-232/110
1,11	F 00V C12 522	11-23-232/111
1,12	F 00V C12 524	11-23-232/112
1,13	F 00V C12 526	11-23-232/113
1,14	F 00V C12 528	11-23-232/114
1,15	F 00V C12 530	11-23-232/115
1,16	F 00V C12 532	11-23-232/116
1,17	F 00V C12 534	11-23-232/117
1,18	F 00V C12 536	11-23-232/118
1,19	F 00V C12 538	11-23-232/119
1,20	F 00V C12 540	11-23-232/120
1,21	F 00V C12 542	11-23-232/121
1,22	F 00V C12 544	11-23-232/122
1,23	F 00V C12 546	11-23-232/123
1,24	F 00V C12 548	11-23-232/124
1,25	F 00V C12 550	11-23-232/125
1,26	F 00V C12 552	11-23-232/126
1,27	F 00V C12 554	11-23-232/127
1,28	F 00V C12 556	11-23-232/128
1,29	F 00V C12 558	11-23-232/129
1,30	F 00V C12 560	11-23-232/130
1,31	F 00V C12 562	11-23-232/131
1,32	F 00V C12 564	11-23-232/132
1,33	F 00V C12 566	11-23-232/133
1,34	F 00V C12 568	11-23-232/134
1,35	F 00V C12 570	11-23-232/135
1,36	F 00V C12 572	11-23-232/136

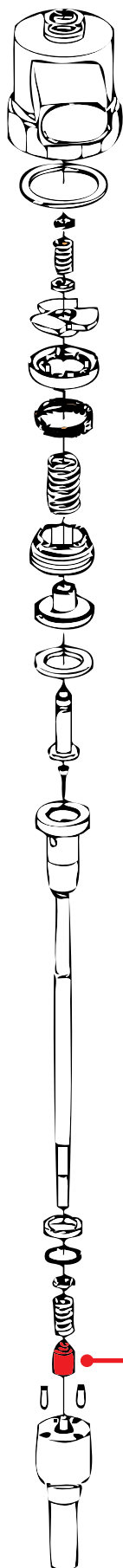

BOSCH

**VECCHIA VERSIONE**

PERNO CILINDRICO
cylindrical pin
pasador cilíndrico

da 8,40... a 8,70

ALTRE MISURE DISPONIBILI A RICHIESTA

Other sizes available upon request

Otros tamaños disponibles bajo petición

Другие размеры доступны по запросу

根据要求提供其它尺寸

Codice OMS	Spessore	Incremento	n° pezzi
11-23-274	da 8,50 a 8,70	0,01	210



valigetta 24 posizioni
handbag 24 position

Codice OMS	Spessore	Incremento	n° pezzi
11-23-227	da 8,40 a 8,50	0,01	110



valigetta 12 posizioni
hanbag 12 position

Codice OMS	Spessore	Incremento	n° pezzi
11-23-299	da 8,40 a 8,70	0,01	310



valigetta 36 posizioni
handbag 36 position

codice singoli spessori
code individual thicknesses

misura	cod. OMS
8,40	11-23-227/840
8,41	11-23-227/841
8,42	11-23-227/842
8,43	11-23-227/843
8,44	11-23-227/844
8,45	11-23-227/845
8,46	11-23-227/846
8,47	11-23-227/847
8,48	11-23-227/848
8,49	11-23-227/849
8,50	11-23-227/850
8,51	11-23-227/851
8,52	11-23-227/852
8,53	11-23-227/853
8,54	11-23-227/854
8,55	11-23-227/855
8,56	11-23-227/856
8,57	11-23-227/857
8,58	11-23-227/858
8,59	11-23-227/859
8,60	11-23-227/860
8,61	11-23-227/861
8,62	11-23-227/862
8,63	11-23-227/863
8,64	11-23-227/864
8,65	11-23-227/865
8,66	11-23-227/866
8,67	11-23-227/867
8,68	11-23-227/868
8,69	11-23-227/869
8,70	11-23-227/870



BOSCH

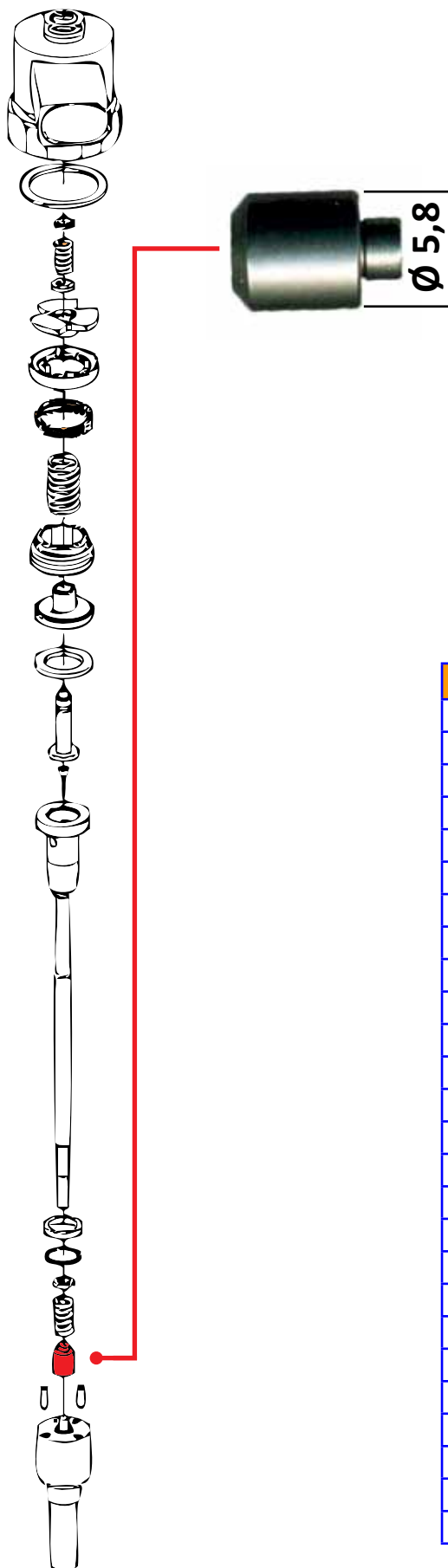

Codice OMS	Spessore	Incremento	n° pezzi
11-23-380	da 8,277 a 8,571	0,012	260



valigetta 36 posizioni
handbag 36 position

VECCHIA VERSIONE

TABELLA CODICI ORIGINALI

misura	rif. originale	cod. OMS
8,277	F 00V C12 400	11-23-227/8277
8,289	F 00V C12 404	11-23-227/8289
8,301	F 00V C12 408	11-23-227/8301
8,313	F 00V C12 412	11-23-227/8313
8,325	F 00V C12 416	11-23-227/8325
8,337	F 00V C12 420	11-23-227/8337
8,349	F 00V C12 424	11-23-227/8349
8,361	F 00V C12 428	11-23-227/8361
8,373	F 00V C12 432	11-23-227/8373
8,385	F 00V C12 436	11-23-227/8385
8,397	F 00V C12 440	11-23-227/8397
8,409	F 00V C12 444	11-23-227/8409
8,421	F 00V C12 448	11-23-227/8421
8,433	F 00V C12 452	11-23-227/8433
8,445	F 00V C12 456	11-23-227/8445
8,457	F 00V C12 460	11-23-227/8457
8,469	F 00V C12 464	11-23-227/8469
8,481	F 00V C12 468	11-23-227/8481
8,493	F 00V C12 472	11-23-227/8493
8,505	F 00V C12 476	11-23-227/8505
8,517	F 00V C12 480	11-23-227/8517
8,529	F 00V C12 484	11-23-227/8529
8,541	F 00V C12 488	11-23-227/8541
8,553	F 00V C12 492	11-23-227/8553
8,565	F 00V C12 496	11-23-227/8565
8,571	F 00V C12 498	11-23-227/8571



BOSCH

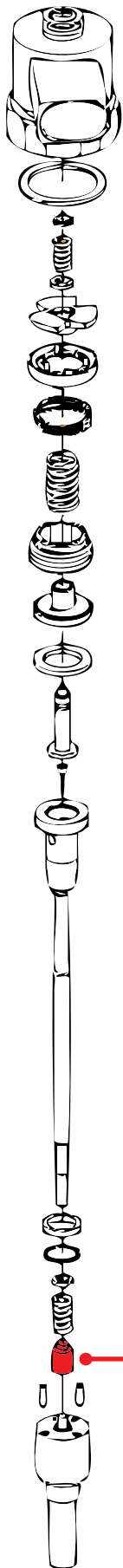

Ø 5,5

NUOVA VERSIONE

PERNO CILINDRICO
cylindrical pin
pasador cilíndrico

da 8,40... a 8,70

ALTRE MISURE DISPONIBILI A RICHIESTA

Other sizes available upon request
Otros tamaños disponibles bajo petición
Другие размеры доступны по запросу
根据要求提供其它尺寸

Codice OMS	Spessore	Incremento	n° pezzi
11-23-723	da 8,50 a 8,70	0,01	210



valigetta 24 posizioni
handbag 24 position

Codice OMS	Spessore	Incremento	n° pezzi
11-23-724	da 8,40 a 8,50	0,01	110



valigetta 12 posizioni
hanbag 12 position

Codice OMS	Spessore	Incremento	n° pezzi
11-23-725	da 8,40 a 8,70	0,01	310



valigetta 36 posizioni
handbag 36 position

codice singoli spessori
code individual thicknesses

misura	cod. OMS
8,40	11-23-723/840
8,41	11-23-723/841
8,42	11-23-723/842
8,43	11-23-723/843
8,44	11-23-723/844
8,45	11-23-723/845
8,46	11-23-723/846
8,47	11-23-723/847
8,48	11-23-723/848
8,49	11-23-723/849
8,50	11-23-723/850
8,51	11-23-723/851
8,52	11-23-723/852
8,53	11-23-723/853
8,54	11-23-723/854
8,55	11-23-723/855
8,56	11-23-723/856
8,57	11-23-723/857
8,58	11-23-723/858
8,59	11-23-723/859
8,60	11-23-723/860
8,61	11-23-723/861
8,62	11-23-723/862
8,63	11-23-723/863
8,64	11-23-723/864
8,65	11-23-723/865
8,66	11-23-723/866
8,67	11-23-723/867
8,68	11-23-723/868
8,69	11-23-723/869
8,70	11-23-723/870



BOSCH

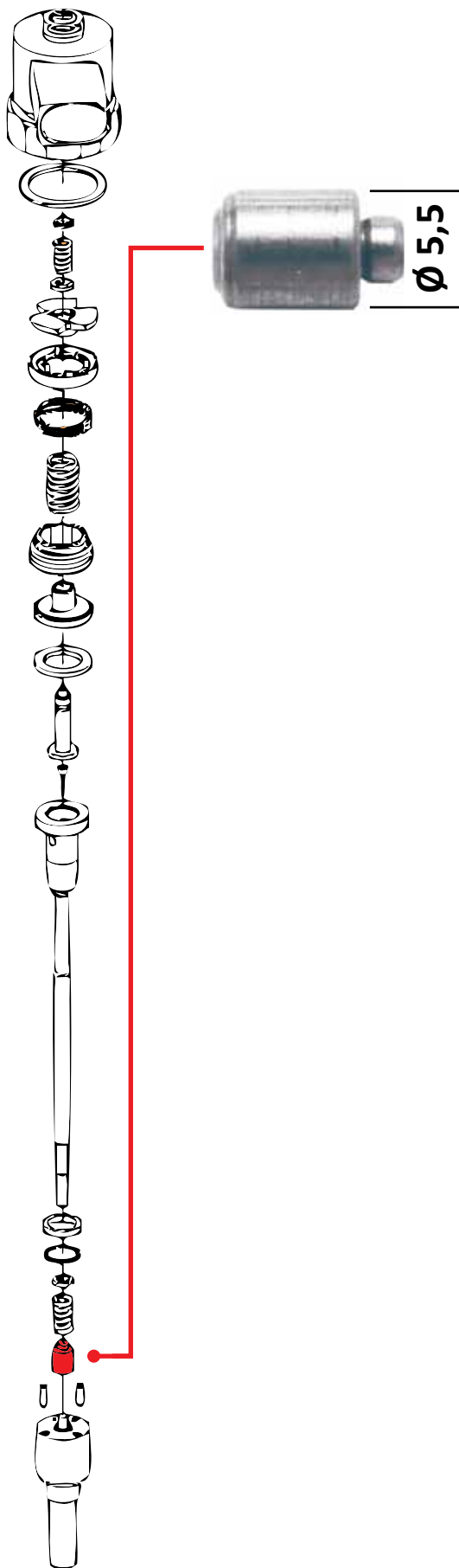

Codice OMS	Spessore	Incremento	n° pezzi
11-23-726	da 8,277 a 8,571	0,012	260



valigetta 36 posizioni
handbag 36 position

NUOVA VERSIONE TABELLA CODICI ORIGINALI

misura	rif. originale	cod. OMS
8,277	F 00V C12 400	11-23-723/8277
8,289	F 00V C12 404	11-23-723/8289
8,301	F 00V C12 408	11-23-723/8301
8,313	F 00V C12 412	11-23-723/8313
8,325	F 00V C12 416	11-23-723/8325
8,337	F 00V C12 420	11-23-723/8337
8,349	F 00V C12 424	11-23-723/8349
8,361	F 00V C12 428	11-23-723/8361
8,373	F 00V C12 432	11-23-723/8373
8,385	F 00V C12 436	11-23-723/8385
8,397	F 00V C12 440	11-23-723/8397
8,409	F 00V C12 444	11-23-723/8409
8,421	F 00V C12 448	11-23-723/8421
8,433	F 00V C12 452	11-23-723/8433
8,445	F 00V C12 456	11-23-723/8445
8,457	F 00V C12 460	11-23-723/8457
8,469	F 00V C12 464	11-23-723/8469
8,481	F 00V C12 468	11-23-723/8481
8,493	F 00V C12 472	11-23-723/8493
8,505	F 00V C12 476	11-23-723/8505
8,517	F 00V C12 480	11-23-723/8517
8,529	F 00V C12 484	11-23-723/8529
8,541	F 00V C12 488	11-23-723/8541
8,553	F 00V C12 492	11-23-723/8553
8,565	F 00V C12 496	11-23-723/8565
8,571	F 00V C12 498	11-23-723/8571



BOSCH

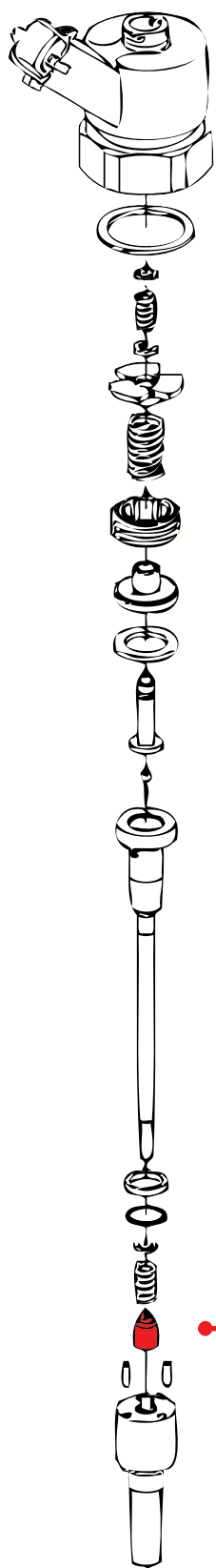

PERNO FRESATO
pin milled
pin molido

da 8,40.. a 8,70

ALTRE MISURE DISPONIBILI A RICHIESTA
Other sizes available upon request
Otros tamaños disponibles bajo petición
Другие размеры доступны по запросу
根据要求提供其它尺寸

Codice OMS	Spessore	Incremento	n° pezzi
11-23-275	da 8,50 a 8,70	0,01	210



valigetta 24 posizioni
handbag 24 position

Codice OMS	Spessore	Incremento	n° pezzi
11-23-104	da 8,40 a 8,50	0,01	110



valigetta 12 posizioni
handbag 12 position

codice singoli spessori
code individual thicknesses

misura	cod. OMS
8,40	11-23-104/840
8,41	11-23-104/841
8,42	11-23-104/842
8,43	11-23-104/843
8,44	11-23-104/844
8,45	11-23-104/845
8,46	11-23-104/846
8,47	11-23-104/847
8,48	11-23-104/848
8,49	11-23-104/849
8,50	11-23-104/850
8,51	11-23-104/851
8,52	11-23-104/852
8,53	11-23-104/853
8,54	11-23-104/854
8,55	11-23-104/855
8,56	11-23-104/856
8,57	11-23-104/857
8,58	11-23-104/858
8,59	11-23-104/859
8,60	11-23-104/860
8,61	11-23-104/861
8,62	11-23-104/862
8,63	11-23-104/863
8,64	11-23-104/864
8,65	11-23-104/865
8,66	11-23-104/866
8,67	11-23-104/867
8,68	11-23-104/868
8,69	11-23-104/869
8,70	11-23-104/870

Codice OMS	Spessore	Incremento	n° pezzi
11-23-298	da 8,40 a 8,70	0,01	310



valigetta 36 posizioni



BOSCH

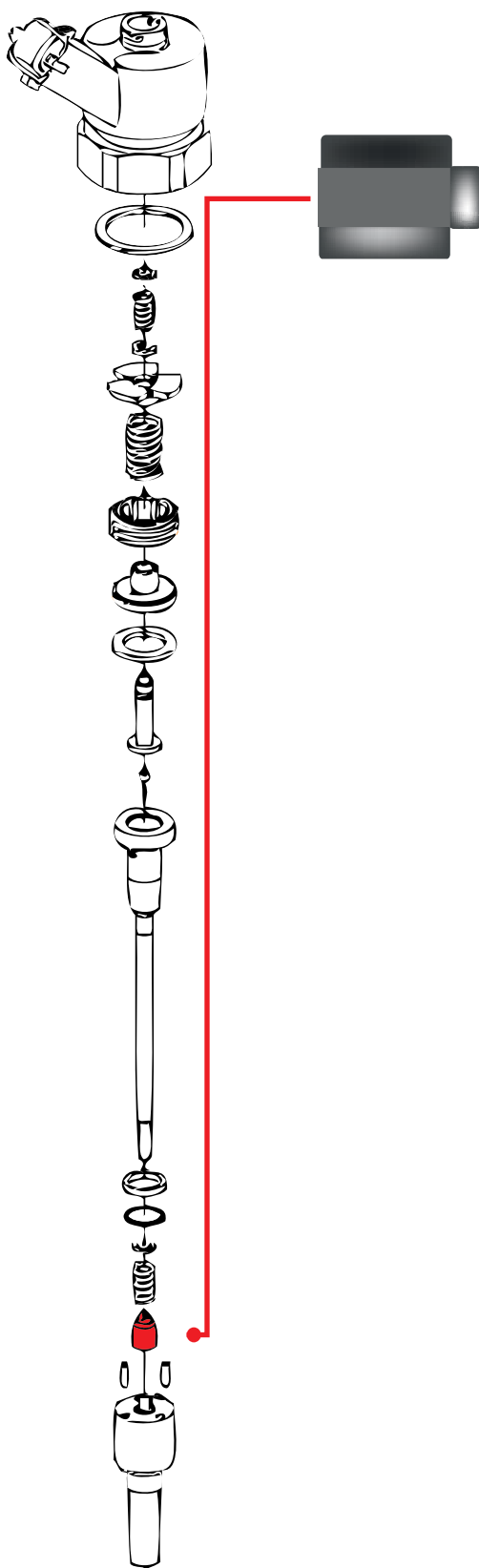

Codice OMS	Spessore	Incremento	n° pezzi
11-23-381	da 8,277 a 8,571	0,012	260



valigetta 36 posizioni
handbag 36 position

TABELLA CODICI ORIGINALI

misura	rif. originale	cod. OMS
8,277	F 00V C12 300	11-23-104/8277
8,289	F 00V C12 304	11-23-104/8289
8,301	F 00V C12 308	11-23-104/8301
8,313	F 00V C12 312	11-23-104/8313
8,325	F 00V C12 316	11-23-104/8325
8,337	F 00V C12 320	11-23-104/8337
8,349	F 00V C12 324	11-23-104/8349
8,361	F 00V C12 328	11-23-104/8361
8,373	F 00V C12 332	11-23-104/8373
8,385	F 00V C12 336	11-23-104/8385
8,397	F 00V C12 340	11-23-104/8397
8,409	F 00V C12 344	11-23-104/8409
8,421	F 00V C12 348	11-23-104/8421
8,433	F 00V C12 352	11-23-104/8433
8,445	F 00V C12 356	11-23-104/8445
8,457	F 00V C12 360	11-23-104/8457
8,469	F 00V C12 364	11-23-104/8469
8,481	F 00V C12 368	11-23-104/8481
8,493	F 00V C12 372	11-23-104/8493
8,505	F 00V C12 376	11-23-104/8505
8,517	F 00V C12 380	11-23-104/8517
8,529	F 00V C12 384	11-23-104/8529
8,541	F 00V C12 388	11-23-104/8541
8,553	F 00V C12 392	11-23-104/8553
8,565	F 00V C12 396	11-23-104/8565
8,571	F 00V C12 398	11-23-104/ 8571



BOSCH

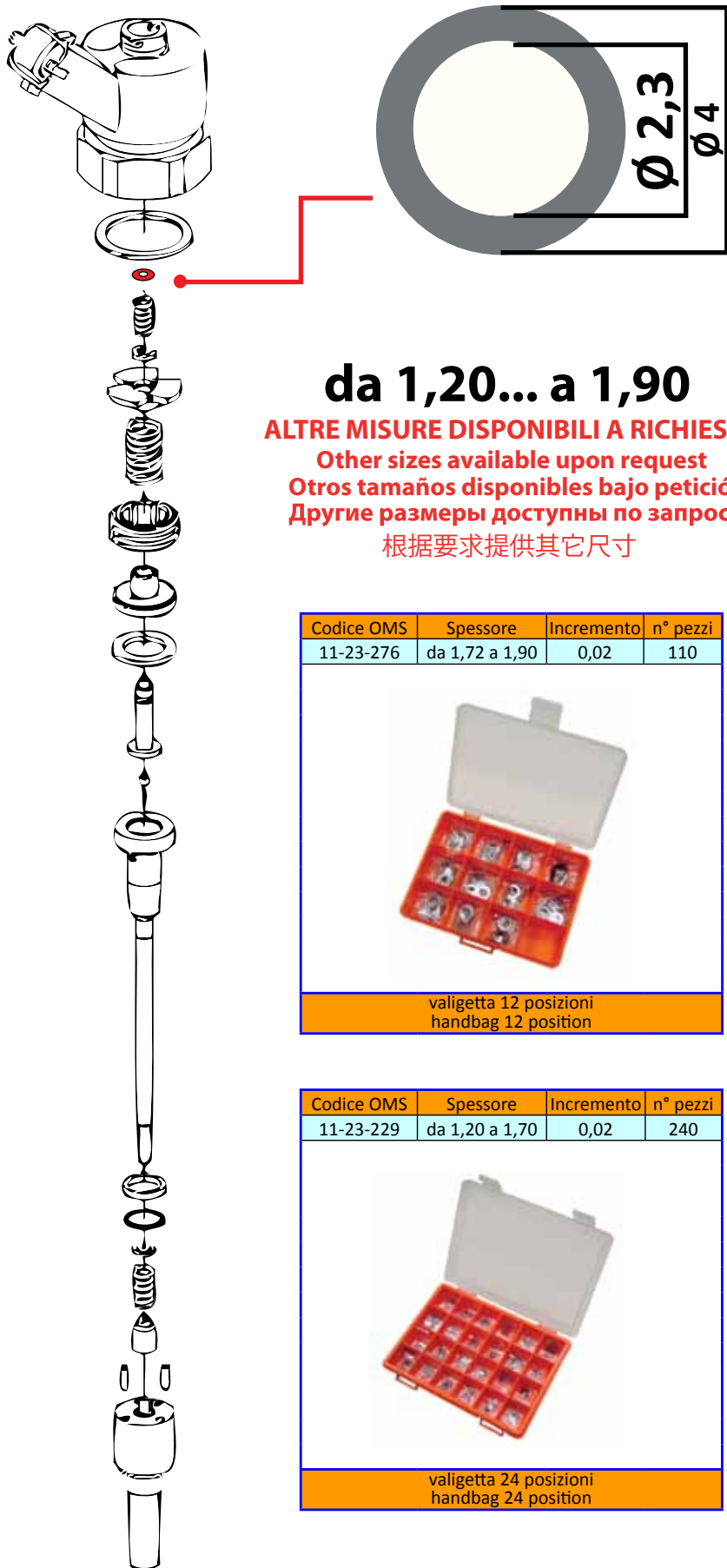

da 1,20... a 1,90

ALTRE MISURE DISPONIBILI A RICHIESTA

Other sizes available upon request
 Otros tamaños disponibles bajo petición
 Другие размеры доступны по запросу
 根据要求提供其它尺寸

Codice OMS	Spessore	Incremento	n° pezzi
11-23-276	da 1,72 a 1,90	0,02	110



valigetta 12 posizioni
handbag 12 position

Codice OMS	Spessore	Incremento	n° pezzi
11-23-229	da 1,20 a 1,70	0,02	240



valigetta 24 posizioni
handbag 24 position

codice singoli spessori
code individual thickness

misura	cod. OMS
1,20	11-23-229/120
1,22	11-23-229/122
1,24	11-23-229/124
1,26	11-23-229/126
1,28	11-23-229/128
1,30	11-23-229/130
1,32	11-23-229/132
1,34	11-23-229/134
1,36	11-23-229/136
1,38	11-23-229/138
1,40	11-23-229/140
1,42	11-23-229/142
1,44	11-23-229/144
1,46	11-23-229/146
1,48	11-23-229/148
1,50	11-23-229/150
1,52	11-23-229/152
1,54	11-23-229/154
1,56	11-23-229/156
1,58	11-23-229/158
1,60	11-23-229/160
1,62	11-23-229/162
1,64	11-23-229/164
1,66	11-23-229/166
1,68	11-23-229/168
1,70	11-23-229/170
1,72	11-23-229/172
1,74	11-23-229/174
1,76	11-23-229/176
1,78	11-23-229/178
1,80	11-23-229/180
1,82	11-23-229/182
1,84	11-23-229/184
1,86	11-23-229/186
1,88	11-23-229/188
1,90	11-23-229/190





BOSCH



da 1,20... a 1,90

ALTRE MISURE DISPONIBILI A RICHIESTA

Other sizes available upon request

Otros tamaños disponibles bajo petición

Другие размеры доступны по запросу

根据要求提供其它尺寸

Codice OMS	Spessore	Incremento	n° pezzi
11-23-417	da 1,20 a 1,90	0,02	360



valigetta 36 posizioni
handbag 36 position



BOSCH

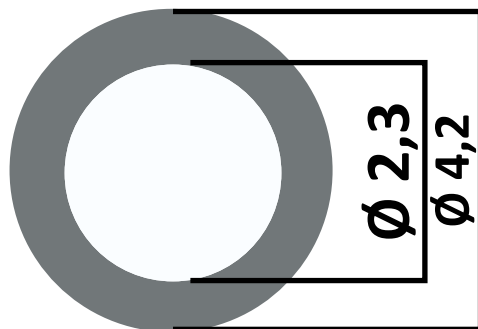
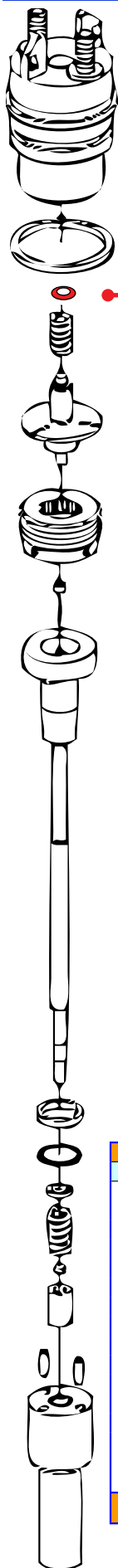

da 1,20.. a 1,96

ALTRE MISURE DISPONIBILI A RICHIESTA

Other sizes available upon request

Otros tamaños disponibles bajo petición

Другие размеры доступны по запросу

根据要求提供其它尺寸

Codice OMS	Spessore	Incremento	n° pezzi
11-23-398	da 1,20 a 1,96	0,02	390



valigetta 54 posizioni
handbag 54 position

Codice OMS	Spessore	Incremento	n° pezzi
11-23-243	da 1,20 a 1,70	0,05	110



valigetta 12 posizioni
handbag 12 position

Codice OMS	Spessore	Incremento	n° pezzi
11-23-228	da 1,20 a 1,70	0,02	240
11-23-270	da 1,70 a 1,96	0,02	140



valigetta 24 posizioni
handbag 24 position

codice singoli spessori
code individual
thicknesses

misura	cod. OMS
1,20	11-23-228/120
1,22	11-23-228/122
1,24	11-23-228/124
1,25	11-23-228/125
1,26	11-23-228/126
1,28	11-23-228/128
1,30	11-23-228/130
1,32	11-23-228/132
1,34	11-23-228/134
1,35	11-23-228/135
1,36	11-23-228/136
1,38	11-23-228/138
1,40	11-23-228/140
1,42	11-23-228/142
1,44	11-23-228/144
1,45	11-23-228/145
1,46	11-23-228/146
1,48	11-23-228/148
1,50	11-23-228/150
1,52	11-23-228/152
1,54	11-23-228/154
1,55	11-23-228/155
1,56	11-23-228/156
1,58	11-23-228/158
1,60	11-23-228/160
1,62	11-23-228/162
1,64	11-23-228/164
1,65	11-23-228/165
1,66	11-23-228/166
1,68	11-23-228/168
1,70	11-23-228/170
1,72	11-23-228/172
1,74	11-23-228/174
1,75	11-23-228/175
1,76	11-23-228/176
1,78	11-23-228/178
1,80	11-23-228/180
1,82	11-23-228/182
1,84	11-23-228/184
1,85	11-23-228/185
1,86	11-23-228/186
1,88	11-23-228/188
1,90	11-23-228/190
1,92	11-23-228/192
1,94	11-23-228/194
1,95	11-23-228/195
1,96	11-23-228/196



BOSCH



TABELLE CODICI ORIGINALI

misura	rif. originale	cod.OMS	misura	rif. originale	cod. OMS
0,80	F 00R J00 481	11-23-228/80	1,32	F 00R J00 199	11-23-228/132
0,82	F 00R J00 482	11-23-228/82	1,34	F 00R J00 280	11-23-228/134
0,84	F 00R J00 483	11-23-228/84	1,36	F 00R J00 200	11-23-228/136
0,86	F 00R J00 484	11-23-228/86	1,38	F 00R J00 281	11-23-228/138
0,88	F 00R J00 485	11-23-228/88	1,40	F 00R J00 201	11-23-228/140
0,90	F 00R J00 486	11-23-228/90	1,42	F 00R J00 282	11-23-228/142
0,92	F 00R J00 189	11-23-228/92	1,44	F 00R J00 202	11-23-228/144
0,94	F 00R J00 207	11-23-228/94	1,46	F 00R J00 283	11-23-228/146
0,96	F 00R J00 190	11-23-228/96	1,48	F 00R J00 203	11-23-228/148
0,98	F 00R J00 271	11-23-228/98	1,50	F 00R J00 284	11-23-228/150
1,00	F 00R J00 191	11-23-228/100	1,52	F 00R J00 204	11-23-228/152
1,02	F 00R J00 272	11-23-228/102	1,54	F 00R J00 285	11-23-228/154
1,04	F 00R J00 192	11-23-228/104	1,56	F 00R J00 205	11-23-228/156
1,06	F 00R J00 273	11-23-228/106	1,58	F 00R J00 286	11-23-228/158
1,08	F 00R J00 193	11-23-228/108	1,60	F 00R J00 206	11-23-228/160
1,10	F 00R J00 274	11-23-228/110	1,62	F 00R J00 287	11-23-228/162
1,12	F 00R J00 194	11-23-228/112	1,64	F 00R J00 207	11-23-228/164
1,14	F 00R J00 275	11-23-228/114			
1,16	F 00R J00 195	11-23-228/116			
1,18	F 00R J00 276	11-23-228/118			
1,20	F 00R J00 196	11-23-228/120			
1,22	F 00R J00 277	11-23-228/122			
1,24	F 00R J00 197	11-23-228/124			
1,26	F 00R J00 278	11-23-228/126			
1,28	F 00R J00 198	11-23-228/128			
1,30	F 00R J00 279	11-23-228/130			



BOSCH

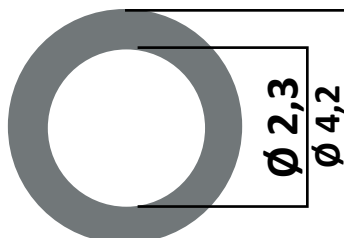
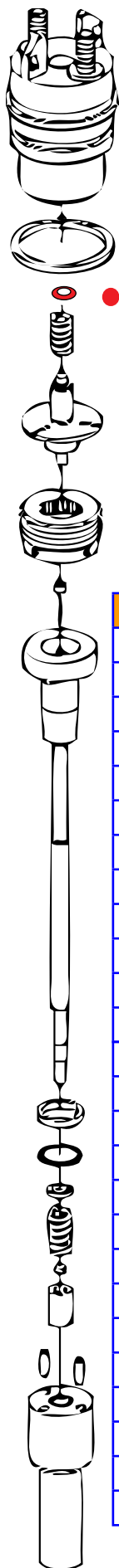
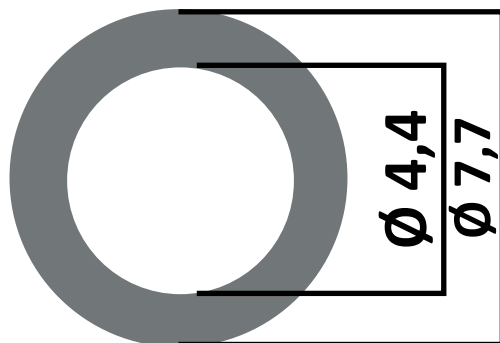
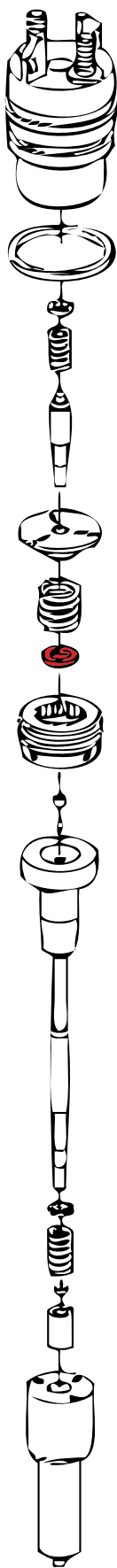

da 0,98...a 1,44

ALTRE MISURE DISPONIBILI A RICHIESTA

Other sizes available upon request

Otros tamaños disponibles bajo petición

Другие размеры доступны по запросу

根据要求提供其它尺寸

Codice OMS	Spessore	Incremento	n° pezzi
11-23-332	da 0,98 a 1,44	0,02	240



valigetta 24 posizioni
handbag 24 position

codice singoli spessori
code individual thicknesses

misura	cod. OMS
0,98	11-23-332/098
1,00	11-23-332/100
1,02	11-23-332/102
1,04	11-23-332/104
1,06	11-23-332/106
1,08	11-23-332/108
1,10	11-23-332/110
1,12	11-23-332/112
1,14	11-23-332/114
1,16	11-23-332/116
1,18	11-23-332/118
1,20	11-23-332/120
1,22	11-23-332/122
1,24	11-23-332/124
1,26	11-23-332/126
1,28	11-23-332/128
1,30	11-23-332/130
1,32	11-23-332/132
1,34	11-23-332/134
1,36	11-23-332/136
1,38	11-23-332/138
1,40	11-23-332/140
1,42	11-23-332/142
1,44	11-23-332/144



BOSCH

TABELLA CODICI ORIGINALI

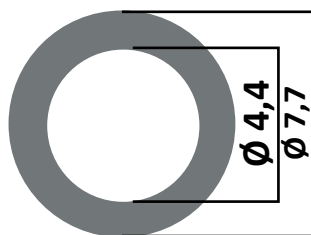
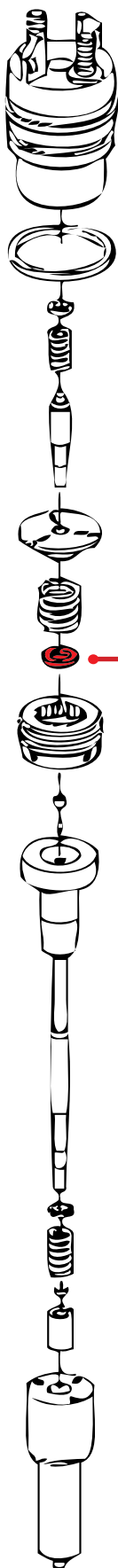

Codice OMS	Spessore	Incremento	n° pezzi
11-23-383	da 0,985 a 1,385	0,01	410



valigetta 54 posizioni
handbag 54 position

misura	rif. originale	cod.oms
0,985	F 00R J01 008	11-23-332/0985
0,995	F 00R J01 009	11-23-332/0995
1,005	F 00R J01 010	11-23-332/1005
1,015	F 00R J01 011	11-23-332/1015
1,025	F 00R J01 012	11-23-332/1025
1,035	F 00R J01 013	11-23-332/1035
1,045	F 00R J01 014	11-23-332/1045
1,055	F 00R J01 015	11-23-332/1055
1,065	F 00R J01 016	11-23-332/1065
1,075	F 00R J01 017	11-23-332/1075
1,085	F 00R J01 018	11-23-332/1085
1,095	F 00R J01 019	11-23-332/1095
1,105	F 00R J01 020	11-23-332/1105
1,115	F 00R J01 021	11-23-332/1115
1,125	F 00R J01 022	11-23-332/1125
1,135	F 00R J01 023	11-23-332/1135
1,145	F 00R J01 024	11-23-332/1145
1,155		11-23-332/1155
1,165		11-23-332/1165
1,175		11-23-332/1175
1,185		11-23-332/1185
1,195		11-23-332/1195
1,205		11-23-332/1205
1,215		11-23-332/1215
1,225		11-23-332/1225
1,235		11-23-332/1235
1,245		11-23-332/1245
1,255		11-23-332/1255
1,265		11-23-332/1265
1,275		11-23-332/1275
1,285		11-23-332/1285
1,295		11-23-332/1295
1,305		11-23-332/1305
1,315		11-23-332/1315
1,325		11-23-332/1325
1,335		11-23-332/1335
1,345		11-23-332/1345
1,355		11-23-332/1355
1,365		11-23-332/1365
1,375		11-23-332/1375
1,385		11-23-332/1385



BOSCH

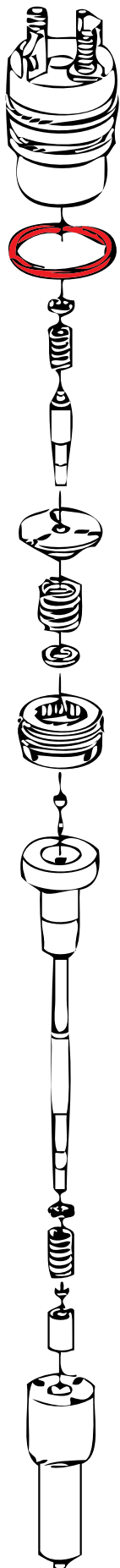

da 1,34...a 1,76

ALTRE MISURE DISPONIBILI A RICHIESTA

Other sizes available upon request

Otros tamaños disponibles bajo petición

Другие размеры доступны по запросу

根据要求提供其它尺寸

Codice OMS	Spessore	Incremento	n° pezzi
11-23-287	da 1,34 a 1,76	0,02	220



valigetta 24 posizioni
handbag 24 position

codice singoli spessori
code individual thicknesses

misura	cod. OMS
1,34	11-23-287/136
1,36	11-23-287/138
1,38	11-23-287/140
1,40	11-23-287/142
1,42	11-23-287/144
1,44	11-23-287/146
1,46	11-23-287/148
1,48	11-23-287/150
1,50	11-23-287/152
1,52	11-23-287/154
1,54	11-23-287/156
1,56	11-23-287/158
1,58	11-23-287/160
1,60	11-23-287/162
1,62	11-23-287/164
1,64	11-23-287/166
1,66	11-23-287/168
1,68	11-23-287/170
1,70	11-23-287/172
1,72	11-23-287/174
1,74	11-23-287/176
1,76	11-23-287/178



BOSCH

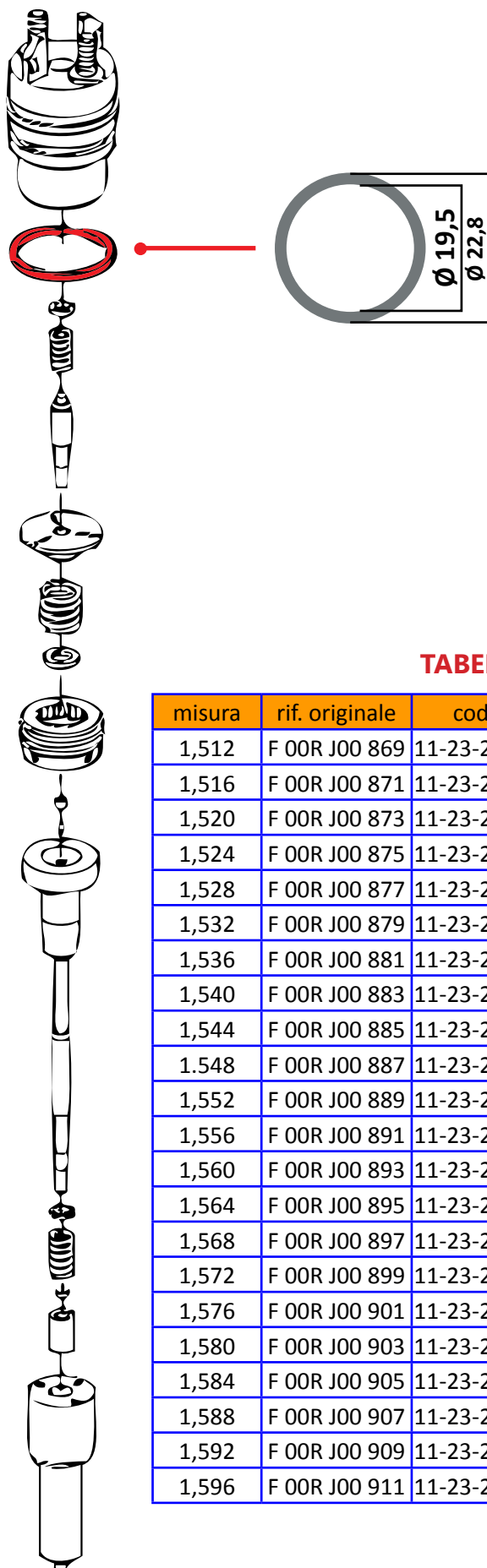

Codice OMS	Spessore	Incremento	n° pezzi
11-23-385	da 1,512 a 1,684	0,004	440



valigetta 54 posizioni
handbag 54 position

TABELLE CODICI ORIGINALI

misura	rif. originale	cod.oms
1,512	F 00R J00 869	11-23-287/1512
1,516	F 00R J00 871	11-23-287/1516
1,520	F 00R J00 873	11-23-287/1520
1,524	F 00R J00 875	11-23-287/1524
1,528	F 00R J00 877	11-23-287/1528
1,532	F 00R J00 879	11-23-287/1532
1,536	F 00R J00 881	11-23-287/1536
1,540	F 00R J00 883	11-23-287/1540
1,544	F 00R J00 885	11-23-287/1544
1,548	F 00R J00 887	11-23-287/1548
1,552	F 00R J00 889	11-23-287/1552
1,556	F 00R J00 891	11-23-287/1556
1,560	F 00R J00 893	11-23-287/1560
1,564	F 00R J00 895	11-23-287/1564
1,568	F 00R J00 897	11-23-287/1568
1,572	F 00R J00 899	11-23-287/1572
1,576	F 00R J00 901	11-23-287/1576
1,580	F 00R J00 903	11-23-287/1580
1,584	F 00R J00 905	11-23-287/1584
1,588	F 00R J00 907	11-23-287/1588
1,592	F 00R J00 909	11-23-287/1592
1,596	F 00R J00 911	11-23-287/1596

misura	rif. originale	cod.oms
1,600	F 00R J00 913	11-23-287/1600
1,604	F 00R J00 915	11-23-287/1604
1,608	F 00R J00 917	11-23-287/1608
1,612	F 00R J00 919	11-23-287/1612
1,616	F 00R J00 921	11-23-287/1616
1,620	F 00R J00 923	11-23-287/1620
1,624	F 00R J00 925	11-23-287/1624
1,628	F 00R J00 927	11-23-287/1628
1,632	F 00R J00 929	11-23-287/1632
1,636	F 00R J00 931	11-23-287/1636
1,640	F 00R J00 933	11-23-287/1640
1,644	F 00R J00 935	11-23-287/1644
1,648	F 00R J00 937	11-23-287/1648
1,652	F 00R J00 939	11-23-287/1652
1,656	F 00R J00 941	11-23-287/1656
1,660	F 00R J00 943	11-23-287/1660
1,664	F 00R J00 945	11-23-287/1664
1,668	F 00R J00 947	11-23-287/1668
1,672	F 00R J00 949	11-23-287/1672
1,676	F 00R J00 951	11-23-287/1676
1,680	F 00R J00 953	11-23-287/1680
1,684	F 00R J00 955	11-23-287/1684



BOSCH

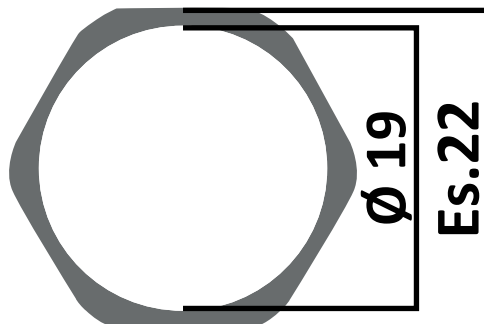
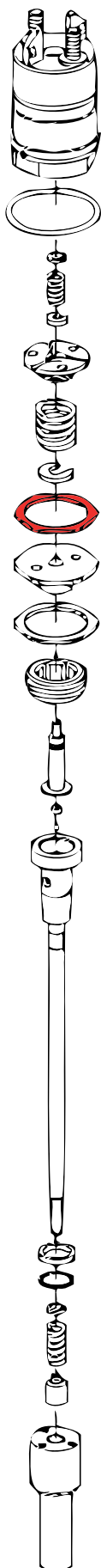

da 0,90.. a 1,40

ALTRE MISURE DISPONIBILI A RICHIESTA
Other sizes available upon request
Otros tamaños disponibles bajo petición
Другие размеры доступны по запросу
根据要求提供其它尺寸

Codice OMS	Spessore	Incremento	n° pezzi
11-23-273	da 0,90 a 1,00	0,01	110
11-23-235	da 1,00 a 1,10	0,01	110
11-23-301	da 1,30 a 1,40	0,01	110



valigetta 12 posizioni
handbag 12 position

Codice OMS	Spessore	Incremento	n° pezzi
11-23-386	da 0,90 a 1,40	0,01	510



valigetta 54 posizioni
handbag 54 position

codice singoli spessori
code individual thicknesses

misura	cod. OMS
0,90	11-23-235/090
0,91	11-23-235/091
0,92	11-23-235/092
0,93	11-23-235/093
0,94	11-23-235/094
0,95	11-23-235/095
0,96	11-23-235/096
0,97	11-23-235/097
0,98	11-23-235/098
0,99	11-23-235/099
1,00	11-23-235/100
1,01	11-23-235/101
1,02	11-23-235/102
1,03	11-23-235/103
1,04	11-23-235/104
1,05	11-23-235/105
1,06	11-23-235/106
1,07	11-23-235/107
1,08	11-23-235/108
1,09	11-23-235/109
1,10	11-23-235/110
1,11	11-23-235/111
1,12	11-23-235/112
1,13	11-23-235/113
1,14	11-23-235/114
1,15	11-23-235/115
1,16	11-23-235/116
1,17	11-23-235/117
1,18	11-23-235/118
1,19	11-23-235/119
1,20	11-23-235/120
1,21	11-23-235/121
1,22	11-23-235/122
1,23	11-23-235/123
1,24	11-23-235/124
1,25	11-23-235/125
1,26	11-23-235/126
1,27	11-23-235/127
1,28	11-23-235/128
1,29	11-23-235/129
1,30	11-23-235/130
1,31	11-23-235/131
1,32	11-23-235/132
1,33	11-23-235/133
1,34	11-23-235/134
1,35	11-23-235/135
1,36	11-23-235/136
1,37	11-23-235/137
1,38	11-23-235/138
1,39	11-23-235/139
1,40	11-23-235/140



BOSCH

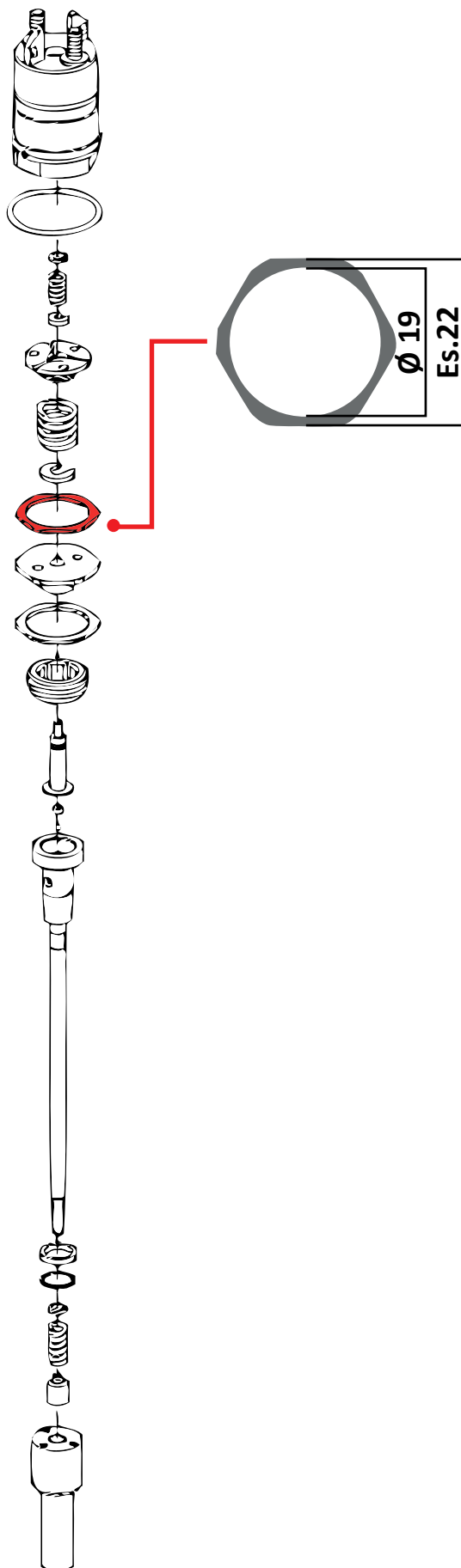

Codice OMS	Spessore	Incremento	n° pezzi
11-23-387	da 1,21 a 1,38	0,01	180



valigetta 24 posizioni
handbag 24 position

TABELLA CODICI ORIGINALI

misura	rif. originale	cod.OMS
1,21	F 00R J00 120	11-23-235/121
1,22	F 00R J00 122	11-23-235/122
1,23	F 00R J00 124	11-23-235/123
1,24	F 00R J00 126	11-23-235/124
1,25	F 00R J00 128	11-23-235/125
1,26	F 00R J00 130	11-23-235/126
1,27	F 00R J00 132	11-23-235/127
1,28	F 00R J00 134	11-23-235/128
1,29	F 00R J00 136	11-23-235/129
1,30	F 00R J00 138	11-23-235/130
1,31	F 00R J00 140	11-23-235/131
1,32	F 00R J00 142	11-23-235/132
1,33	F 00R J00 144	11-23-235/133
1,34	F 00R J00 146	11-23-235/134
1,35	F 00R J00 148	11-23-235/135
1,36	F 00R J00 150	11-23-235/136
1,37	F 00R J00 152	11-23-235/137
1,38	F 00R J00 154	11-23-235/138



BOSCH

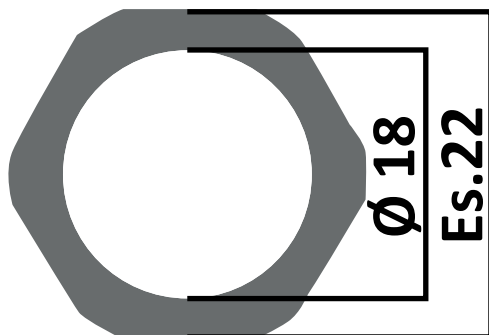
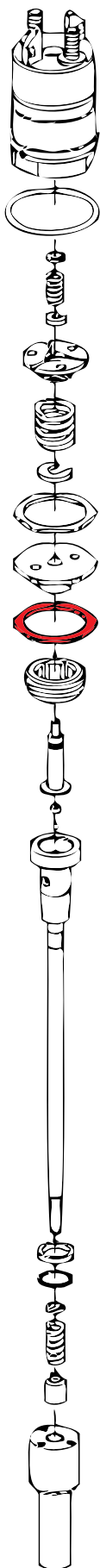

da 0,90... a 1,12

ALTRE MISURE DISPONIBILI A RICHIESTA

Other sizes available upon request

Otros tamaños disponibles bajo petición
Другие размеры доступны по запросу

根据要求提供其它尺寸

Codice OMS	Spessore	Incremento	n° pezzi
11-23-325	da 0,90 a 1,00	0,01	110
11-23-288	da 1,00 a 1,10	0,01	110



valigetta 12 posizioni
handbag 12 position

Codice OMS	Spessore	Incremento	n° pezzi
11-23-397	da 0,90 a 1,12	0,01	230



valigetta 24 posizioni
handbag 24 position

codice singoli spessori

misura	cod. OMS
0,90	11-23-288/090
0,91	11-23-288/091
0,92	11-23-288/092
0,93	11-23-288/093
0,94	11-23-288/094
0,95	11-23-288/095
0,96	11-23-288/096
0,97	11-23-288/097
0,98	11-23-288/098
0,99	11-23-288/099
1,00	11-23-288/100
1,01	11-23-288/101
1,02	11-23-288/102
1,03	11-23-288/103
1,04	11-23-288/104
1,05	11-23-288/105
1,06	11-23-288/106
1,07	11-23-288/107
1,08	11-23-288/108
1,09	11-23-288/109
1,10	11-23-288/110
1,11	11-23-288/111
1,12	11-23-288/112



BOSCH

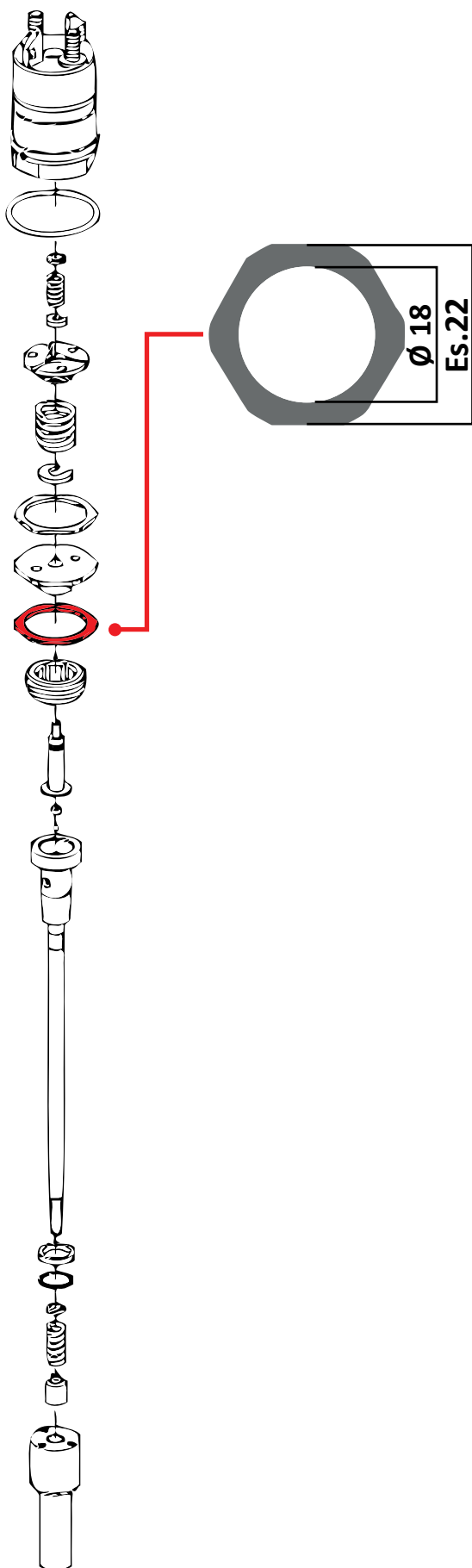

Codice OMS	Spessore	Incremento	n° pezzi
11-23-388	da 0,950 a 1,054	0,004	270



valigetta 36 posizioni
handbag 36 position

TABELLA CODICI ORIGINALI

misura	rif. originale	cod.OMS
0,950	F 00R J00 024	11-23-288/0950
0,954	F 00R J00 026	11-23-288/0954
0,958	F 00R J00 028	11-23-288/0958
0,962	F 00R J00 030	11-23-288/0962
0,966	F 00R J00 032	11-23-288/0966
0,970	F 00R J00 034	11-23-288/0970
0,974	F 00R J00 036	11-23-288/0974
0,978	F 00R J00 038	11-23-288/0978
0,982	F 00R J00 040	11-23-288/0982
0,986	F 00R J00 042	11-23-288/0986
0,990	F 00R J00 044	11-23-288/0990
0,994	F 00R J00 046	11-23-288/0994
0,998	F 00R J00 048	11-23-288/0998
1,002	F 00R J00 050	11-23-288/1002
1,006	F 00R J00 052	11-23-288/1006
1,010	F 00R J00 054	11-23-288/1010
1,014	F 00R J00 056	11-23-288/1014
1,018	F 00R J00 058	11-23-288/1018
1,022	F 00R J00 060	11-23-288/1022
1,026	F 00R J00 062	11-23-288/1026
1,030	F 00R J00 064	11-23-288/1030
1,034	F 00R J00 066	11-23-288/1034
1,038	F 00R J00 068	11-23-288/1038
1,042	F 00R J00 070	11-23-288/1042
1,046	F 00R J00 072	11-23-288/1046
1,050	F 00R J00 074	11-23-288/1050
1,054	F 00R J00 076	11-23-288/1054



BOSCH

TABELLA CODICI ORIGINALI

misura	ref. originale	cod. OMS
0,78		11-23-389/078
0,79		11-23-389/079
0,80		11-23-389/080
0,81		11-23-389/081
0,82	F 00R J01 347	11-23-389/082
0,83	F 00R J01 349	11-23-389/083
0,84	F 00R J01 351	11-23-389/084
0,85	F 00R J01 353	11-23-389/085
0,86	F 00R J01 355	11-23-389/086
0,87	F 00R J01 357	11-23-389/087
0,88	F 00R J01 359	11-23-389/088
0,89	F 00R J01 361	11-23-389/089
0,90	F 00R J01 363	11-23-389/090
0,91	F 00R J01 365	11-23-389/091
0,92	F 00R J01 367	11-23-389/092
0,93	F 00R J01 369	11-23-389/093
0,94	F 00R J01 371	11-23-389/094
0,95	F 00R J01 373	11-23-389/095
0,96	F 00R J01 375	11-23-389/096
0,97	F 00R J01 377	11-23-389/097
0,98	F 00R J01 379	11-23-389/098
0,99	F 00R J01 381	11-23-389/099
1,00	F 00R J01 383	11-23-389/100
1,01	F 00R J01 385	11-23-389/101
1,02	F 00R J01 387	11-23-389/102
1,03	F 00R J01 389	11-23-389/103
1,04	F 00R J01 391	11-23-389/104
1,05	F 00R J01 393	11-23-389/105
1,06	F 00R J01 395	11-23-389/106
1,07	F 00R J01 397	11-23-389/107
1,08	F 00R J01 399	11-23-389/108
1,09	F 00R J01 401	11-23-389/109
1,10	F 00R J01 403	11-23-389/110
1,11	F 00R J01 405	11-23-389/111
1,12	F 00R J01 407	11-23-389/112
1,13	F 00R J01 409	11-23-389/113
1,14	F 00R J01 411	11-23-389/114
1,15	F 00R J01 413	11-23-389/115
1,16	F 00R J01 415	11-23-389/116
1,17	F 00R J01 417	11-23-389/117
1,18	F 00R J01 419	11-23-389/118
1,19		11-23-389/119
1,20		11-23-389/120
1,21		11-23-389/121
1,22		11-23-389/122
1,23		11-23-389/123
1,24		11-23-389/124
1,25		11-23-389/125

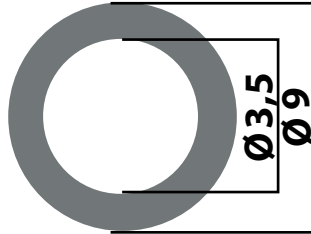
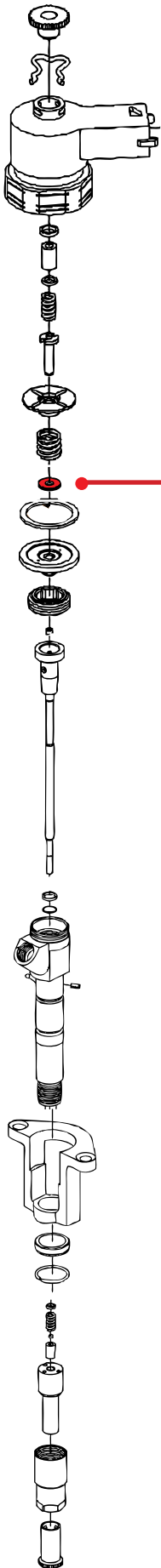

da 0,78... a 1,25

ALTRE MISURE DISPONIBILI A RICHIESTA

Other sizes available upon request
 Otros tamaños disponibles bajo petición
 Другие размеры доступны по запросу
 根据要求提供其它尺寸

Codice OMS	Spessore	Incremento	n° pezzi
11-23-389	da 0,78 a 1,25	0,01	480



valigetta 54 posizioni
handbag 54 position



BOSCH



da 1,20... a 1,90

ALTRE MISURE DISPONIBILI A RICHIESTA

Other sizes available upon request

Otros tamaños disponibles bajo petición

Другие размеры доступны по запросу

根据要求提供其它尺寸

Codice OMS	Spessore	Incremento	n° pezzi
11-23-272	da 1,72 a 1,90	0,02	100



valigetta 12 posizioni
handbag 12 position

Codice OMS	Spessore	Incremento	n° pezzi
11-23-231	da 1,20 a 1,70	0,02	240



valigetta 24 posizioni
handbag 24 position

codice singoli spessori
code individual thicknesses

misura	cod. OMS
1,20	11-23-231/120
1,22	11-23-231/122
1,24	11-23-231/124
1,26	11-23-231/126
1,28	11-23-231/128
1,30	11-23-231/130
1,32	11-23-231/132
1,34	11-23-231/134
1,36	11-23-231/136
1,38	11-23-231/138
1,40	11-23-231/140
1,42	11-23-231/142
1,44	11-23-231/144
1,46	11-23-231/146
1,48	11-23-231/148
1,50	11-23-231/150
1,52	11-23-231/152
1,54	11-23-231/154
1,56	11-23-231/156
1,58	11-23-231/158
1,60	11-23-231/160
1,62	11-23-231/162
1,64	11-23-231/164
1,66	11-23-231/166
1,68	11-23-231/168
1,70	11-23-231/170
1,72	11-23-231/172
1,74	11-23-231/174
1,76	11-23-231/176
1,78	11-23-231/178
1,80	11-23-231/180
1,82	11-23-231/182
1,84	11-23-231/184
1,86	11-23-231/186
1,88	11-23-231/188
1,90	11-23-231/190



BOSCH

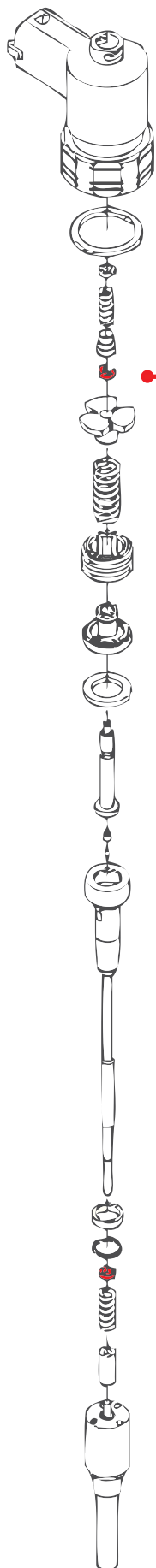

da 1,155...a 1,265

ALTRE MISURE DISPONIBILI A RICHIESTA

Other sizes available upon request
 Otros tamaños disponibles bajo petición
 Другие размеры доступны по запросу
 根据要求提供其它尺寸

Codice OMS	Spessore	Incremento	n° pezzi
11-23-396	da 1,155 a 1,265	0,01	120



valigetta 12 posizioni
 handbag 12 position

TABELLA CODICI ORIGINALI

misura	rif. originale	cod.OMS
1,155	F 00V C18 300	11-23-396/1155
1,165	F 00V C18 302	11-23-396/1165
1,175	F 00V C18 304	11-23-396/1175
1,185	F 00V C18 306	11-23-396/1185
1,195	F 00V C18 308	11-23-396/1195
1,205	F 00V C18 310	11-23-396/1205
1,215	F 00V C18 312	11-23-396/1215
1,225	F 00V C18 314	11-23-396/1225
1,235	F 00V C18 316	11-23-396/1235
1,245	F 00V C18 318	11-23-396/1245
1,255	F 00V C18 320	11-23-396/1255
1,265	F 00V C18 322	11-23-396/1265



PDE 100-90

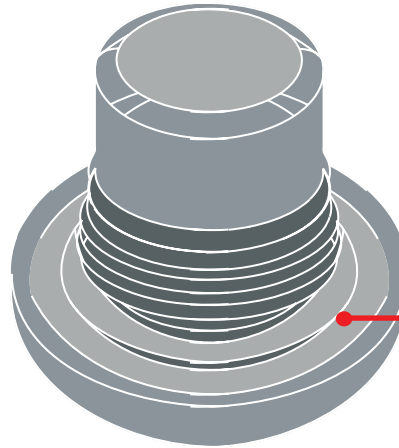

CON SEDE OR
with seat OR

da 14,66.. a 14,88

ALTRE MISURE DISPONIBILI A RICHIESTA

Other sizes available upon request

Otros tamaños disponibles bajo petición

Другие размеры доступны по запросу

根据要求提供其它尺寸

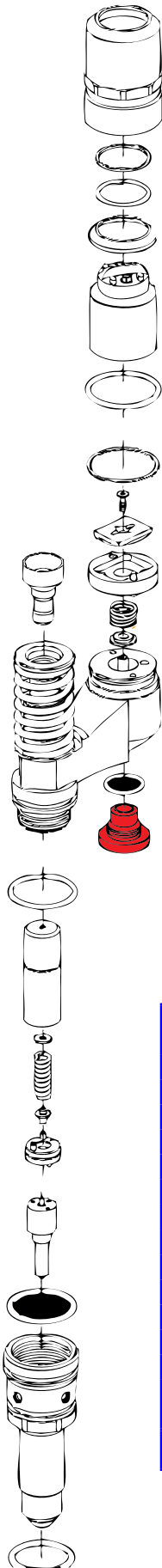

Codice OMS	Spessore	Incremento	n° pezzi
11-23-390	da 14,66 a 14,88	0,02	60



valigetta 12 posizioni
handbag 12 position

codice singoli spessori
code individual thicknesses

misura	cod. OMS
14,66	11-23-390/1466
14,68	11-23-390/1468
14,70	11-23-390/1470
14,72	11-23-390/1472
14,74	11-23-390/1474
14,76	11-23-390/1476
14,78	11-23-390/1478
14,80	11-23-390/1480
14,82	11-23-390/1482
14,84	11-23-390/1484
14,86	11-23-390/1486
14,88	11-23-390/1488



PDE 100-90

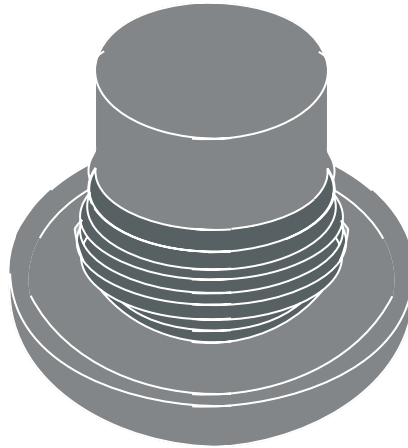
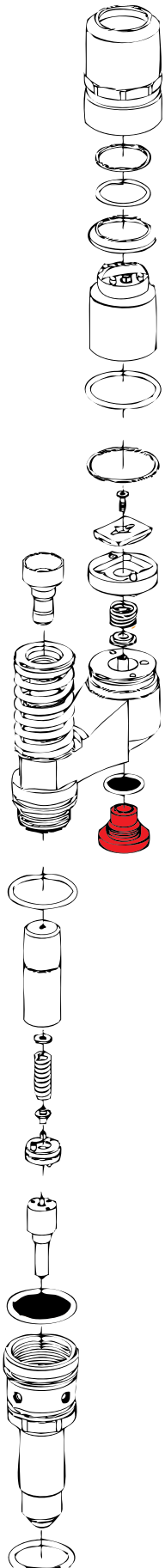

da 14,56... a 15,10

ALTRE MISURE DISPONIBILI A RICHIESTA
Other sizes available upon request
Otros tamaños disponibles bajo petición
Другие размеры доступны по запросу
根据要求提供其它尺寸

codice singoli spessori
code individual
thicknesses

misura	cod. OMS
14,56	11-23-391/1456
14,58	11-23-391/1458
14,60	11-23-391/1460
14,62	11-23-391/1462
14,64	11-23-391/1464
14,66	11-23-391/1466
14,68	11-23-391/1468
14,70	11-23-391/1470
14,72	11-23-391/1472
14,74	11-23-391/1474
14,76	11-23-391/1476
14,78	11-23-391/1478
14,80	11-23-391/1480
14,82	11-23-391/1482
14,84	11-23-391/1484
14,86	11-23-391/1486
14,88	11-23-391/1488
14,90	11-23-391/1490
14,92	11-23-391/1492
14,94	11-23-391/1494
14,96	11-23-391/1496
14,98	11-23-391/1498
15,00	11-23-391/1500
15,02	11-23-391/1502
15,04	11-23-391/1504
15,06	11-23-391/1506
15,08	11-23-391/1508
15,10	11-23-391/1510

Codice OMS	Spessore	Incremento	n° pezzi
11-23-391	da 14,56 a 14,78	0,02	60



valigetta 12 posizioni
handbag 12 position

Codice OMS	Spessore	Incremento	n° pezzi
11-23-392	da 14,80 a 15,10	0,02	80



valigetta 18 posizioni
handbag 18 position



PLD 1B100-PLD1D110

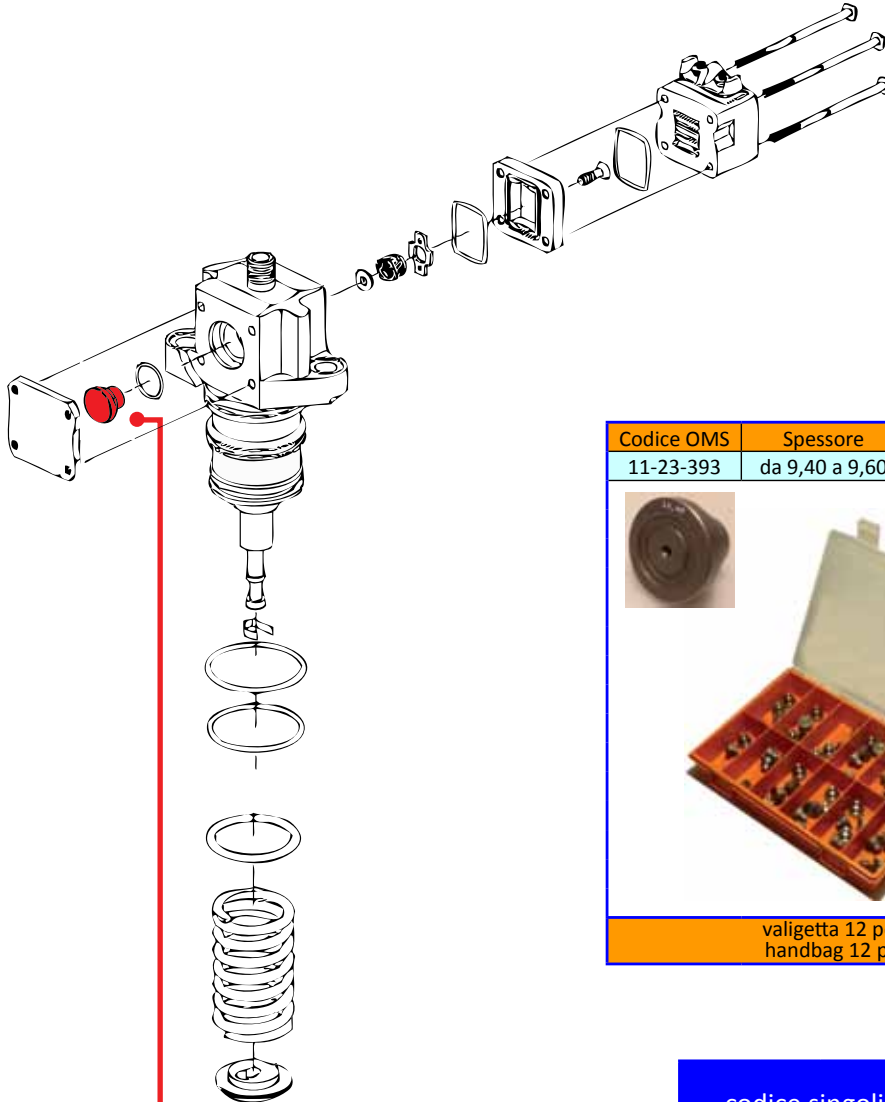

Codice OMS	Spessore	Incremento	n° pezzi
11-23-393	da 9,40 a 9,60	0,02	55



valigetta 12 posizioni
handbag 12 position

codice singoli spessori
code individual thicknesses

misura	cod. OMS
9,40	11-23-393/940
9,42	11-23-393/942
9,44	11-23-393/944
9,46	11-23-393/946
9,48	11-23-393/948
9,50	11-23-393/950
9,52	11-23-393/952
9,54	11-23-393/954
9,56	11-23-393/956
9,58	11-23-393/958
9,60	11-23-393/960

da 9,40... a 9,60

ALTRE MISURE DISPONIBILI A RICHIESTA

Other sizes available upon request

Otros tamaños disponibles bajo petición

Другие размеры доступны по запросу

根据要求提供其它尺寸



SIEMENS

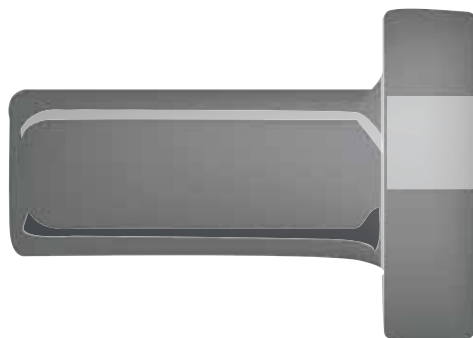
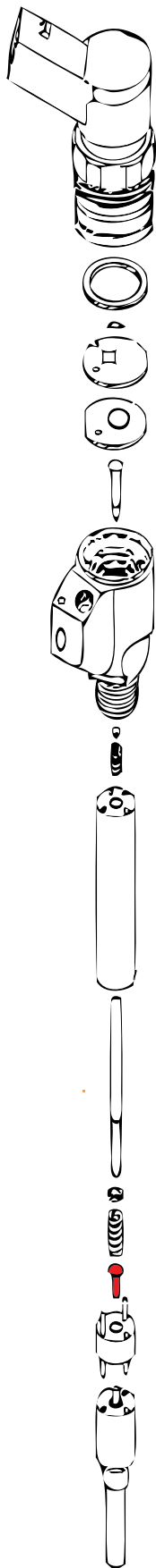

da 7,76... a 8,18

ALTRE MISURE DISPONIBILI A RICHIESTA

Other sizes available upon request

Otros tamaños disponibles bajo petición

Другие размеры доступны по запросу

根据要求提供其它尺寸

Codice OMS	Spessore	Incremento	n° pezzi
11-23-342	da 7,76 a 8,18	0,02	220



valigetta 24 posizioni
handbag 24 position

codice singoli spessori
code individual thicknesses

misura	cod. OMS
7,76	11-23-342/776
7,78	11-23-342/778
7,80	11-23-342/780
7,82	11-23-342/782
7,84	11-23-342/784
7,86	11-23-342/786
7,88	11-23-342/788
7,90	11-23-342/790
7,92	11-23-342/792
7,94	11-23-342/794
7,96	11-23-342/796
7,98	11-23-342/798
8,00	11-23-342/800
8,02	11-23-342/802
8,04	11-23-342/804
8,06	11-23-342/806
8,08	11-23-342/808
8,10	11-23-342/810
8,12	11-23-342/812
8,14	11-23-342/814
8,16	11-23-342/816
8,18	11-23-342/818



SIEMENS

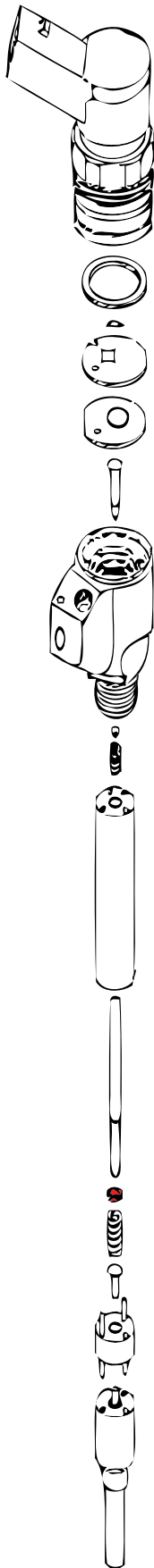

da 1,20 ... a 1,90

ALTRE MISURE DISPONIBILI A RICHIESTA
Other sizes available upon request
Otros tamaños disponibles bajo petición
Другие размеры доступны по запросу
根据要求提供其它尺寸

Codice OMS	Spessore	Incremento	n° pezzi
11-23-335	da 1,25 a 1,80	0,05	120



valigetta 12 posizioni
handbag 12 position

Codice OMS	Spessore	Incremento	n° pezzi
11-23-336	da 1,26 a 1,72	0,02	240



valigetta 24 posizioni
handbag 24 position

Codice OMS	Spessore	Incremento	n° pezzi
11-23-414	da 1,20 a 1,90	0,02	360



valigetta 36 posizioni
handbag 36 position

codice singoli spessori
code individual thicknesses

misura	cod. OMS
1,20	11-23-335/120
1,22	11-23-335/122
1,24	11-23-335/124
1,25	11-23-335/125
1,26	11-23-335/126
1,28	11-23-335/128
1,30	11-23-335/130
1,32	11-23-335/132
1,34	11-23-335/134
1,35	11-23-335/135
1,36	11-23-335/136
1,38	11-23-335/138
1,40	11-23-335/140
1,42	11-23-335/142
1,44	11-23-335/144
1,45	11-23-335/145
1,46	11-23-335/146
1,48	11-23-335/148
1,50	11-23-335/150
1,52	11-23-335/152
1,54	11-23-335/154
1,55	11-23-335/155
1,56	11-23-335/156
1,58	11-23-335/158
1,60	11-23-335/160
1,62	11-23-335/162
1,64	11-23-335/164
1,65	11-23-335/165
1,66	11-23-335/166
1,68	11-23-335/168
1,70	11-23-335/170
1,72	11-23-335/172
1,74	11-23-335/174
1,75	11-23-335/175
1,76	11-23-335/176
1,78	11-23-335/178
1,80	11-23-335/180
1,82	11-23-335/182
1,84	11-23-335/184
1,86	11-23-335/186
1,88	11-23-335/188
1,90	11-23-335/190



SIEMENS

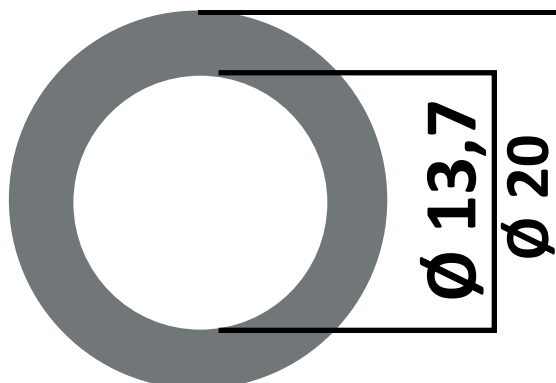
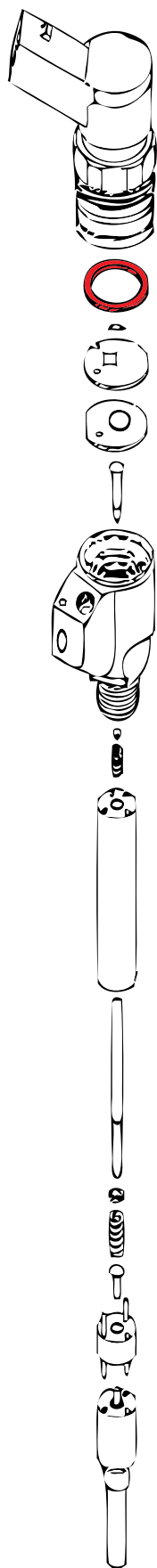

da 0,80.. a 1,20

ALTRE MISURE DISPONIBILI A RICHIESTA

Other sizes available upon request
 Otros tamaños disponibles bajo petición
 Другие размеры доступны по запросу
 根据要求提供其它尺寸

Codice OMS	Spessore	Incremento	n° pezzi
11-23-262	da 0,80 a 1,20	0,02	210



valigetta 24 posizioni
handbag 24 position

codice singoli spessori
code individual thicknesses

misura	cod. OMS
0,80	11-23-262/080
0,82	11-23-262/082
0,84	11-23-262/084
0,86	11-23-262/086
0,88	11-23-262/088
0,90	11-23-262/090
0,92	11-23-262/092
0,94	11-23-262/094
0,96	11-23-262/096
0,98	11-23-262/098
1,00	11-23-262/100
1,02	11-23-262/102
1,04	11-23-262/104
1,06	11-23-262/106
1,08	11-23-262/108
1,10	11-23-262/110
1,12	11-23-262/112
1,14	11-23-262/114
1,16	11-23-262/116
1,18	11-23-262/118
1,20	11-23-262/120



SIEMENS

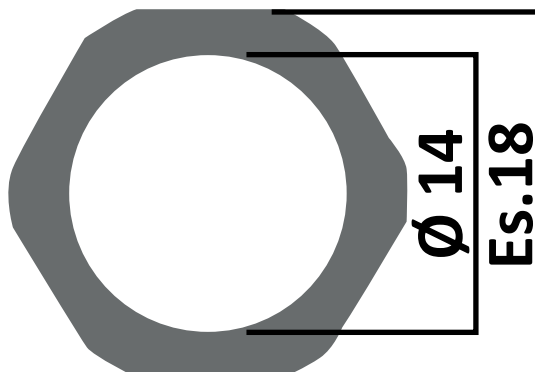
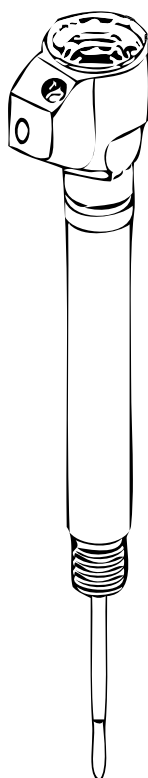
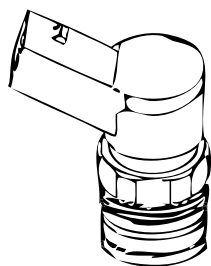

da 0,90... a 1,13

ALTRE MISURE DISPONIBILI A RICHIESTA

Other sizes available upon request

Otros tamaños disponibles bajo petición

Другие размеры доступны по запросу

根据要求提供其它尺寸

Codice OMS	Spessore	Incremento	n° pezzi
11-23-337	da 0,90 a 1,13	0,01	240



valigetta 24 posizioni
handbag 24 position

codice singoli spessori
code individual thicknesses

misura	cod. OMS
0,90	11-23-337/090
0,91	11-23-337/091
0,92	11-23-337/092
0,93	11-23-337/093
0,94	11-23-337/094
0,95	11-23-337/095
0,96	11-23-337/096
0,97	11-23-337/097
0,98	11-23-337/098
0,99	11-23-337/099
1,00	11-23-337/100
1,01	11-23-337/101
1,02	11-23-337/102
1,03	11-23-337/103
1,04	11-23-337/104
1,05	11-23-337/105
1,06	11-23-337/106
1,07	11-23-337/107
1,08	11-23-337/108
1,09	11-23-337/109
1,10	11-23-337/110
1,11	11-23-337/111
1,12	11-23-337/112
1,13	11-23-337/113

DELPHI Iniettore Pompa

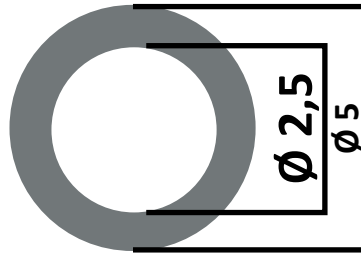

da 0,502... a 0,995

ALTRE MISURE DISPONIBILI A RICHIESTA

Other sizes available upon request

Otros tamaños disponibles bajo petición

Другие размеры доступны по запросу

根据要求提供其它尺寸



misura	rif. originale	cod.OMS
0,502	7206-0188A	11-23-415/502
0,519	7206-0188B	11-23-415/519
0,536	7206-0188C	11-23-415/536
0,553	7206-0188D	11-23-415/553
0,570	7206-0188E	11-23-415/570
0,587	7206-0188F	11-23-415/587
0,604	7206-0188G	11-23-415/604
0,621	7206-0188H	11-23-415/621
0,638	7206-0188J	11-23-415/638
0,655	7206-0188K	11-23-415/655
0,672	7206-0188L	11-23-415/672
0,689	7206-0188M	11-23-415/689
0,706	7206-0188N	11-23-415/706
0,723	7206-0188P	11-23-415/723
0,740	7206-0188Q	11-23-415/740

misura	rif. originale	cod.OMS
0,757	7206-0188R	11-23-415/757
0,774	7206-0188S	11-23-415/774
0,791	7206-0188T	11-23-415/791
0,808	7206-0188U	11-23-415/808
0,825	7206-0188V	11-23-415/825
0,842	7206-0188W	11-23-415/842
0,859	7206-0188X	11-23-415/859
0,876	7206-0188Y	11-23-415/876
0,893	7206-0188Z	11-23-415/893
0,910	7206-0188AA	11-23-415/910
0,927	7206-0188AB	11-23-415/927
0,944	7206-0188AC	11-23-415/944
0,961	7206-0188AD	11-23-415/961
0,978	7206-0188AE	11-23-415/978
0,995	7206-0188AF	11-23-415/995





DELPHI Iniettore Pompa



da 0,30.. a 0,58

ALTRE MISURE DISPONIBILI A RICHIESTA
 Other sizes available upon request
 Otros tamaños disponibles bajo petición
 Другие размеры доступны по запросу
 根据要求提供其它尺寸

Codice OMS	Spessore	Incremento	n° pezzi
11-23-394	da 0,30 a 0,58	0,02	100



valigetta 12 posizioni
handbag 12 position

Codice OMS	Spessore	Incremento	n° pezzi
11-23-651	da 0,30 a 1,56	-	190



valigetta 24 posizioni
handbag 24 position

misura	rif. originale	cod.OMS
0,30	7169-706KA	11-23-394/030
0,42	7169-706KB	11-23-394/042
0,44	7169-706KC	11-23-394/044
0,46	7169-706KD	11-23-394/046
0,48	7169-706KE	11-23-394/048
0,50	7169-706KF	11-23-394/050
0,52	7169-706KG	11-23-394/052
0,54	7169-706KH	11-23-394/054
0,56	7169-706KJ	11-23-394/056
0,58	7169-706KK	11-23-394/058

misura	rif. originale	cod.OMS
0,60	7169-706KL	11-23-394/060
0,62	7169-706KM	11-23-394/062
0,64	7169-706KN	11-23-394/064
0,66	7169-706KP	11-23-394/066
0,68	7169-706KR	11-23-394/068
0,70	7169-706KS	11-23-394/070
1,00	7169-706KT	11-23-394/100
1,28	7169-706KU	11-23-394/128
1,56	7169-706KV	11-23-394/156

DELPHI Iniettore Pompa

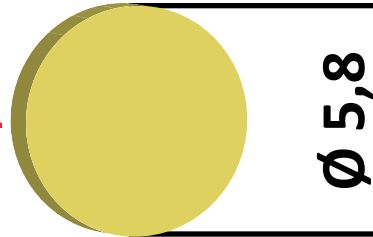
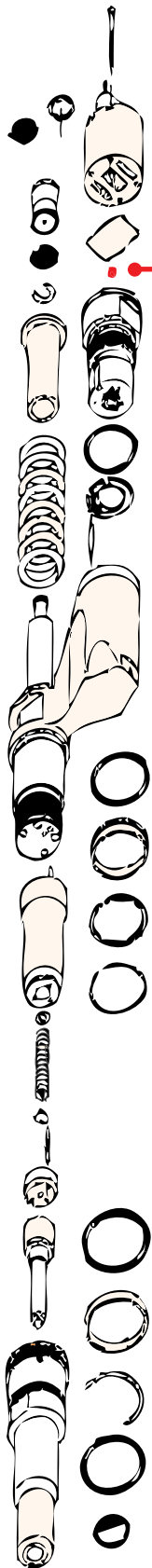

Ø 5,8

OTTONE SENZA FORO
brass without hole
latón sin agujero

da 2,24 ... a 2,94

ALTRE MISURE DISPONIBILI A RICHIESTA
Other sizes available upon request

Otros tamaños disponibles bajo petición
Другие размеры доступны по запросу

根据要求提供其它尺寸

Codice OMS	Spessore	Incremento	n° pezzi
11-23-366	da 2,24 a 2,94	0,02	360



valigetta 36 posizioni
handnag 36 position

misura	rif. originale	cod. OMS
2,24	7204-142A	11-23-366/224
2,26	7204-142B	11-23-366/226
2,28	7204-142C	11-23-366/228
2,30	7204-142D	11-23-366/230
2,32	7204-142E	11-23-366/232
2,34	7204-142F	11-23-366/234
2,36	7204-142G	11-23-366/236
2,38	7204-142H	11-23-366/238
2,40	7204-142J	11-23-366/240
2,42	7204-142K	11-23-366/242
2,44	7204-142L	11-23-366/244
2,46	7204-142M	11-23-366/246
2,48	7204-142N	11-23-366/248
2,50	7204-142P	11-23-366/250
2,52	7204-142Q	11-23-366/252
2,54	7204-142R	11-23-366/254
2,56	7204-142S	11-23-366/256
2,58	7204-142T	11-23-366/258

misura	rif. originale	cod. OMS
2,60	7204-142U	11-23-366/260
2,62	7204-142V	11-23-366/262
2,64	7204-142W	11-23-366/264
2,66	7204-142X	11-23-366/266
2,68	7204-142Y	11-23-366/268
2,70	7204-142Z	11-23-366/270
2,72	7204-142AA	11-23-366/272
2,74	7204-142AB	11-23-366/274
2,76	7204-142AC	11-23-366/276
2,78	7204-142AD	11-23-366/278
2,80	7204-142AE	11-23-366/280
2,82	7204-142AF	11-23-366/282
2,84	7204-142AG	11-23-366/284
2,86	7204-142AH	11-23-366/286
2,88	7204-142AJ	11-23-366/288
2,90	7204-142AK	11-23-366/290
2,92	7204-142AL	11-23-366/292
2,94	7204-142AM	11-23-366/294



DELPHI

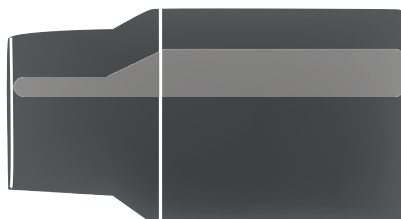
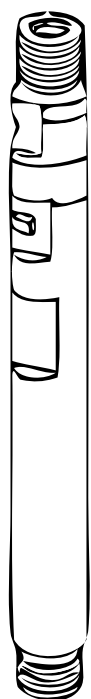

da 3,75.. a 4,90

ALTRE MISURE DISPONIBILI A RICHIESTA

Other sizes available upon request

Otros tamaños disponibles bajo petición

Другие размеры доступны по запросу

根据要求提供其它尺寸

Codice OMS	Spessore	Incremento	n° pezzi
11-23-339	da 3,80 a 4,90	0,10	120



valigetta 12 posizioni
handbag 12 position

Codice OMS	Spessore	Incremento	n° pezzi
11-23-338	da 3,75 a 4,90	0,05	240



valigetta 24 posizioni
handbag 24 position

codice singoli spessori
code individual thicknesses

misura	cod. OMS
3,75	11-23-338/375
3,80	11-23-338/380
3,85	11-23-338/385
3,90	11-23-338/390
3,95	11-23-338/395
4,00	11-23-338/400
4,05	11-23-338/405
4,10	11-23-338/410
4,15	11-23-338/415
4,20	11-23-338/420
4,25	11-23-338/425
4,30	11-23-338/430
4,35	11-23-338/435
4,40	11-23-338/440
4,45	11-23-338/445
4,50	11-23-338/450
4,55	11-23-338/455
4,60	11-23-338/460
4,65	11-23-338/465
4,70	11-23-338/470
4,75	11-23-338/475
4,80	11-23-338/480
4,85	11-23-338/485
4,90	11-23-338/490



DELPHI



da 3,75.. a 4,90

ALTRE MISURE DISPONIBILI A RICHIESTA

Other sizes available upon request
 Otros tamaños disponibles bajo petición
 Другие размеры доступны по запросу
 根据要求提供其它尺寸

Codice OMS	Spessore	Incremento	n° pezzi
11-23-653	da 3,80 a 4,90	0,10	120



Codice OMS	Spessore	Incremento	n° pezzi
11-23-652	da 3,75 a 4,90	0,05	240



codice singoli spessori
code individual thicknesses

misura	cod. OMS
3,75	11-23-652/375
3,80	11-23-652/380
3,85	11-23-652/385
3,90	11-23-652/390
3,95	11-23-652/395
4,00	11-23-652/400
4,05	11-23-652/405
4,10	11-23-652/410
4,15	11-23-652/415
4,20	11-23-652/420
4,25	11-23-652/425
4,30	11-23-652/430
4,35	11-23-652/435
4,40	11-23-652/440
4,45	11-23-652/445
4,50	11-23-652/450
4,55	11-23-652/455
4,60	11-23-652/460
4,65	11-23-652/465
4,70	11-23-652/470
4,75	11-23-652/475
4,80	11-23-652/480
4,85	11-23-652/485
4,90	11-23-652/490



DELPHI

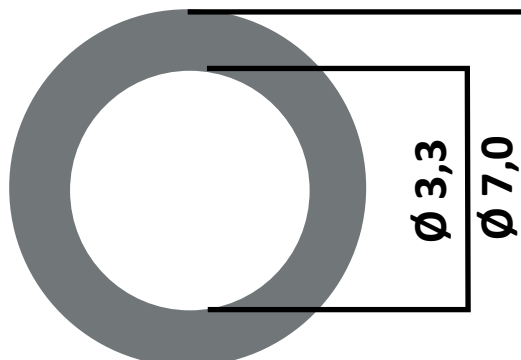
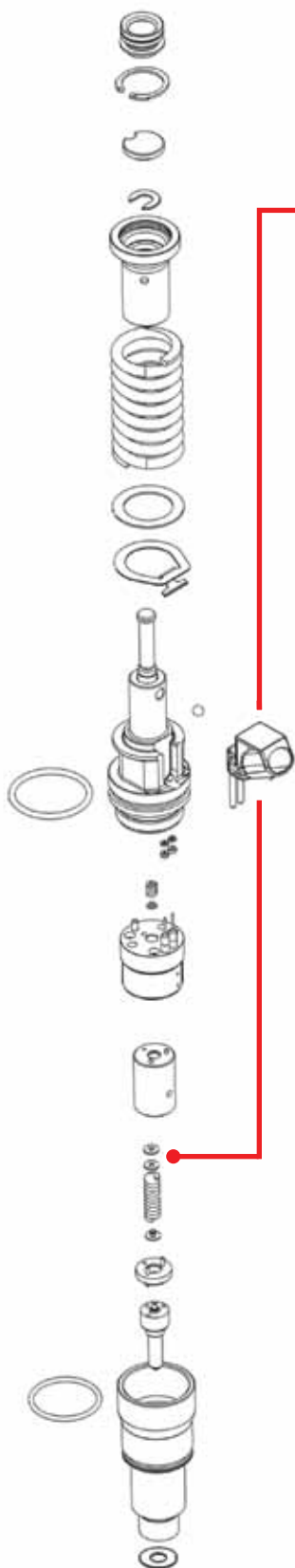

da 0,30 .. a 1,60

ALTRE MISURE DISPONIBILI A RICHIESTA

Other sizes available upon request

Otros tamaños disponibles bajo petición

Другие размеры доступны по запросу

根据要求提供其它尺寸

Codice OMS	Spessore	Incremento	n° pezzi
11-23-727	da 0,30 a 1,60	-	200



valigetta 24 posizioni
handbag 24 position

misura	rif. originale	cod. OMS
0,30	7207-0178A	11-23-727/030
0,42	7207-0178B	11-23-727/042
0,44	7207-0178C	11-23-727/044
0,46	7207-0178D	11-23-727/046
0,48	7207-0178E	11-23-727/048
0,50	7207-0178F	11-23-727/050
0,52	7207-0178G	11-23-727/052
0,54	7207-0178H	11-23-727/054
0,56	7207-0178J	11-23-727/056
0,58	7207-0178K	11-23-727/058
0,60	7207-0178L	11-23-727/060
0,62	7207-0178M	11-23-727/062
0,64	7207-0178N	11-23-727/064
0,66	7207-0178P	11-23-727/066
0,68	7207-0178R	11-23-727/068
0,70	7207-0178S	11-23-727/070
1,00	7207-0178T	11-23-727/100
1,28	7207-0178U	11-23-727/128
1,56	7207-0178V	11-23-727/156
1,60	-	11-23-727/160



DENSO

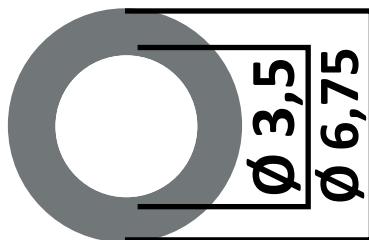
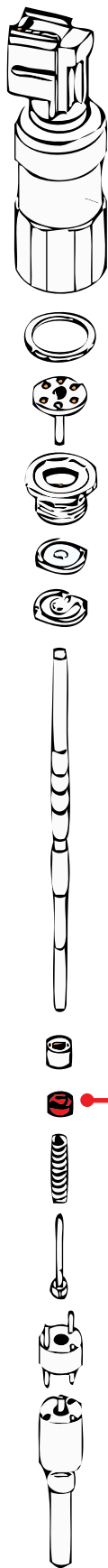

da 1,75.. a 2,30

ALTRE MISURE DISPONIBILI A RICHIESTA

Other sizes available upon request

Otros tamaños disponibles bajo petición

Другие размеры доступны по запросу

根据要求提供其它尺寸

Codice OMS	Spessore	Incremento	n° pezzi
11-23-340	da 1,75 a 2,30	0,05	120



valigetta 12 posizioni
handbag 12 position

codice singoli spessori
code individual thicknesses

misura	cod. OMS
1,75	11-23-340/175
1,80	11-23-340/180
1,85	11-23-340/185
1,90	11-23-340/190
1,95	11-23-340/195
2,00	11-23-340/200
2,05	11-23-340/205
2,10	11-23-340/210
2,15	11-23-340/215
2,20	11-23-340/220
2,25	11-23-340/225
2,30	11-23-340/230



DENSO

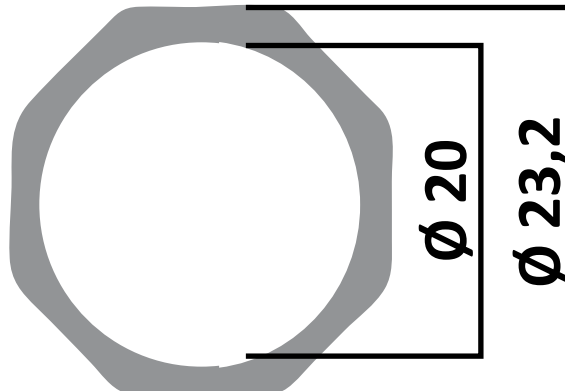

da 2,99... a 3,15

ALTRE MISURE DISPONIBILI A RICHIESTA

Other sizes available upon request

Otros tamaños disponibles bajo petición

Другие размеры доступны по запросу

根据要求提供其它尺寸

Codice OMS	Spessore	Incremento	n° pezzi
11-23-341	da 2,99 a 3,10	0,01	120



valigetta 24 posizioni
handbag 24 position

Codice OMS	Spessore	Incremento	n° pezzi
11-23-418	da 2,99 a 3,15	0,01	170



valigetta 24 posizioni
handbag 24 position

codice singoli spessori
code individual thicknesses

misura	cod. OMS
2,99	11-23-341/299
3,00	11-23-341/300
3,01	11-23-341/301
3,02	11-23-341/302
3,03	11-23-341/303
3,04	11-23-341/304
3,05	11-23-341/305
3,06	11-23-341/306
3,07	11-23-341/307
3,08	11-23-341/308
3,09	11-23-341/309
3,10	11-23-341/310
3,11	11-23-341/311
3,12	11-23-341/312
3,13	11-23-341/313
3,14	11-23-341/314
3,15	11-23-341/315



DENSO

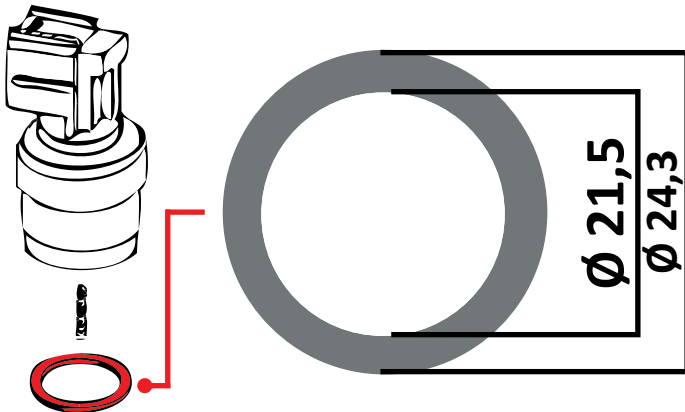

da 1,20... a 1,75

ALTRE MISURE DISPONIBILI A RICHIESTA

Other sizes available upon request

Otros tamaños disponibles bajo petición

Другие размеры доступны по запросу

根据要求提供其它尺寸

codice singoli spessori
code individual
thicknesses

misura	cod. OMS
1,20	11-23-343/120
1,21	11-23-343/121
1,22	11-23-343/122
1,23	11-23-343/123
1,24	11-23-343/124
1,25	11-23-343/125
1,26	11-23-343/126
1,27	11-23-343/127
1,28	11-23-343/128
1,29	11-23-343/129
1,30	11-23-343/130
1,31	11-23-343/131
1,32	11-23-343/132
1,33	11-23-343/133
1,34	11-23-343/134
1,35	11-23-343/135
1,36	11-23-343/136
1,37	11-23-343/137
1,38	11-23-343/138
1,39	11-23-343/139
1,40	11-23-343/140
1,41	11-23-343/141
1,42	11-23-343/142
1,43	11-23-343/143
1,44	11-23-343/144
1,45	11-23-343/145
1,46	11-23-343/146

misura	cod. OMS
1,47	11-23-343/147
1,48	11-23-343/148
1,49	11-23-343/149
1,50	11-23-343/150
1,51	11-23-343/151
1,52	11-23-343/152
1,53	11-23-343/153
1,54	11-23-343/154
1,55	11-23-343/155
1,56	11-23-343/156
1,57	11-23-343/157
1,58	11-23-343/158
1,59	11-23-343/159
1,60	11-23-343/160
1,61	11-23-343/161
1,62	11-23-343/162
1,63	11-23-343/163
1,64	11-23-343/164
1,65	11-23-343/165
1,66	11-23-343/166
1,67	11-23-343/167
1,68	11-23-343/168
1,69	11-23-343/169
1,70	11-23-343/170
1,71	11-23-343/171
1,72	11-23-343/172
1,73	11-23-343/173
1,74	11-23-343/174

Codice OMS	Spessore	Incremento	n° pezzi
11-23-344	da 1,50 a 1,72	0,01	230



valigetta 24 posizioni
handbag24position

Codice OMS	Spessore	Incremento	n° pezzi
11-23-343	da 1,50 a 1,72	0,02	120



valigetta 12 posizioni
handbag 12 position





DENSO

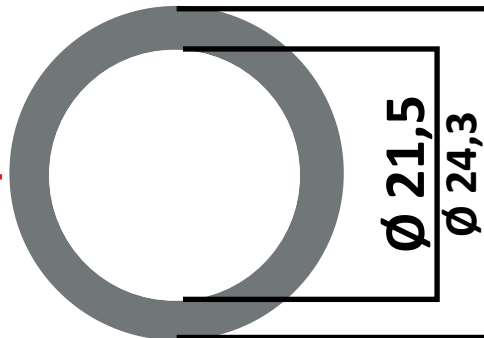
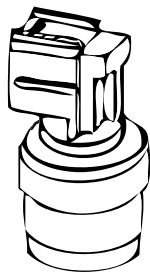

da 1,20 ... a 1,74

ALTRE MISURE DISPONIBILI A RICHIESTA

Other sizes available upon request

Otros tamaños disponibles bajo petición
Другие размеры доступны по запросу

根据要求提供其它尺寸



codice singoli spessori code individual thicknesses	
misura	cod. OMS

1,435	11-23-343/1435
1,44	11-23-343/144
1,445	11-23-343/1445
1,45	11-23-343/145
1,455	11-23-343/1455
1,46	11-23-343/146
1,465	11-23-343/1465
1,47	11-23-343/147
1,475	11-23-343/1475
1,48	11-23-343/148
1,485	11-23-343/1485
1,49	11-23-343/149
1,495	11-23-343/1495
1,50	11-23-343/150
1,505	11-23-343/1505
1,51	11-23-343/151
1,515	11-23-343/1515
1,52	11-23-343/152
1,525	11-23-343/1525
1,53	11-23-343/153
1,535	11-23-343/1535
1,54	11-23-343/154
1,545	11-23-343/1545
1,55	11-23-343/155
1,555	11-23-343/1555
1,56	11-23-343/156
1,565	11-23-343/1565

codice singoli spessori code individual thicknesses	
misura	cod. OMS

1,57	11-23-343/157
1,575	11-23-343/1575
1,58	11-23-343/158
1,585	11-23-343/1585
1,59	11-23-343/159
1,595	11-23-343/1595
1,60	11-23-343/160
1,605	11-23-343/1605
1,61	11-23-343/161
1,615	11-23-343/1615
1,62	11-23-343/162
1,625	11-23-343/1625
1,63	11-23-343/163
1,635	11-23-343/1635
1,64	11-23-343/164
1,645	11-23-343/1645
1,65	11-23-343/165
1,655	11-23-343/1655
1,66	11-23-343/166
1,665	11-23-343/1665
1,67	11-23-343/167
1,675	11-23-343/1675
1,68	11-23-343/168
1,685	11-23-343/1685
1,69	11-23-343/169
1,695	11-23-343/1695
1,70	11-23-343/170

Codice OMS	Spessore	Incremento	n° pezzi
------------	----------	------------	----------

11-23-399	da 1,20 a 1,74	0,02	280
-----------	----------------	------	-----



valigetta 36 posizioni
handbag 36 position

Codice OMS	Spessore	Incremento	n° pezzi
------------	----------	------------	----------

11-23-400	da 1,20 a 1,73	0,01	540
-----------	----------------	------	-----



valigetta 54 posizioni
handbag 54 position

Codice OMS	Spessore	Incremento	n° pezzi
------------	----------	------------	----------

11-23-715	da 1,435 a 1,70	0,05	540
-----------	-----------------	------	-----



valigetta 54 posizioni
handbag 54 position



DENSO

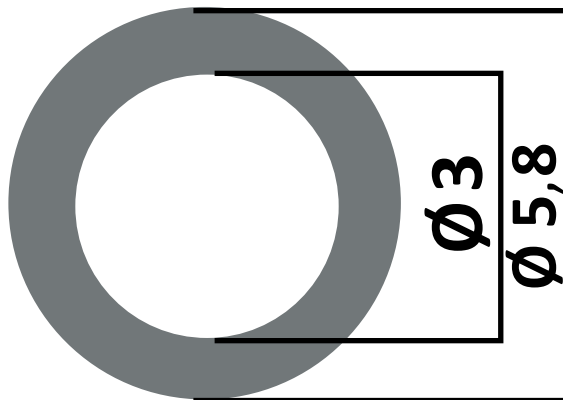
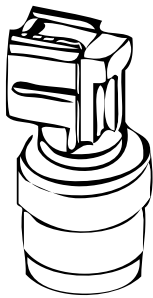

da 1,10.. a 1,65

ALTRE MISURE DISPONIBILI A RICHIESTA
 Other sizes available upon request
 Otros tamaños disponibles bajo petición
 Другие размеры доступны по запросу
 根据要求提供其它尺寸

Codice OMS	Spessore	Incremento	n° pezzi
11-23-395	da 1,10 a 1,65	0,05	120



valigetta 12posizioni
handbag 12 position

Codice OMS	Spessore	Incremento	n° pezzi
11-23-416	da 1,10 a 1,60	0,02	260



valigetta 36 posizioni
handbag 36 position

codice singoli spessori
code individual thicknesses

misura	cod. OMS
1,10	11-23-395/110
1,12	11-23-395/112
1,14	11-23-395/114
1,15	11-23-395/115
1,16	11-23-395/116
1,18	11-23-395/118
1,20	11-23-395/120
1,22	11-23-395/122
1,24	11-23-395/124
1,25	11-23-395/125
1,26	11-23-395/126
1,28	11-23-395/128
1,30	11-23-395/130
1,32	11-23-395/132
1,34	11-23-395/134
1,35	11-23-395/135
1,36	11-23-395/136
1,38	11-23-395/138
1,40	11-23-395/140
1,42	11-23-395/142
1,44	11-23-395/144
1,45	11-23-395/145
1,46	11-23-395/146
1,48	11-23-395/148
1,50	11-23-395/150
1,52	11-23-395/152
1,54	11-23-395/154
1,55	11-23-395/155
1,56	11-23-395/156
1,58	11-23-395/158
1,60	11-23-395/160
1,65	11-23-395/165



BOSCH

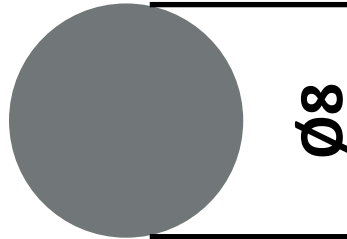
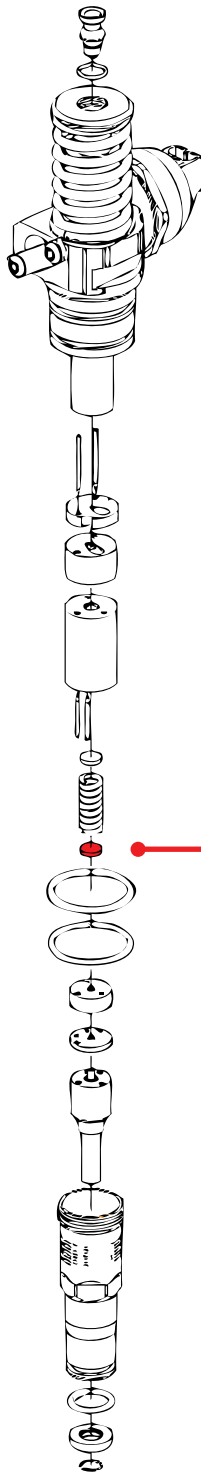

da 1,00.. a 1,45

ALTRE MISURE DISPONIBILI A RICHIESTA

Other sizes available upon request

Otros tamaños disponibles bajo petición

Другие размеры доступны по запросу

根据要求提供其它尺寸

Codice OMS	Spessore	Incremento	n° pezzi
02-20-016	da 1,00 a 1,45	0,02	240



valigetta 24 posizioni
handbag 24 position

codice singoli spessori
code individual thicknesses

misura	cod.OMS	codice originale
1,00	02-20-016/100	1 410 067 016
1,01	02-20-016/101	1 410 067 141
1,03	02-20-016/103	1 410 067 142
1,05	02-20-016/105	1 410 067 143
1,07	02-20-016/107	1 410 067 144
1,09	02-20-016/109	1 410 067 145
1,11	02-20-016/111	1 410 067 146
1,13	02-20-016/113	1 410 067 147
1,15	02-20-016/115	1 410 067 148
1,17	02-20-016/117	1 410 067 149
1,19	02-20-016/119	1 410 067 150
1,21	02-20-016/121	1 410 067 151
1,23	02-20-016/123	1 410 067 152
1,25	02-20-016/125	1 410 067 153
1,27	02-20-016/127	1 410 067 154
1,29	02-20-016/129	1 410 067 155
1,31	02-20-016/131	1 410 067 156
1,33	02-20-016/133	1 410 067 157
1,35	02-20-016/135	1 410 067 158
1,37	02-20-016/137	1 410 067 159
1,39	02-20-016/139	1 410 067 160
1,41	02-20-016/141	1 410 067 161
1,43	02-20-016/143	1 410 067 162
1,45	02-20-016/145	1 410 067 163



BOSCH

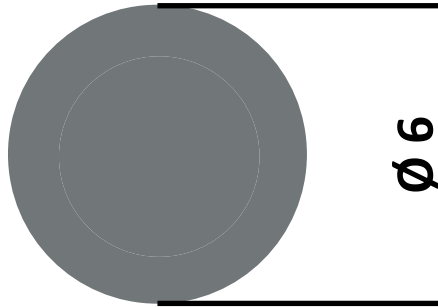
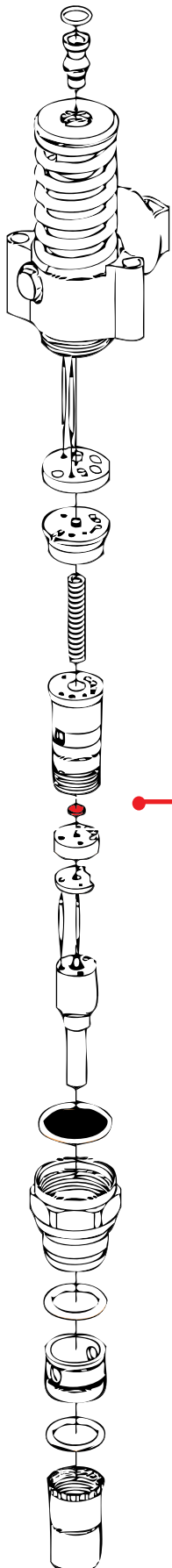

da 1,00.. a 1,45

ALTRE MISURE DISPONIBILI A RICHIESTA

Other sizes available upon request

Otros tamaños disponibles bajo petición

Другие размеры доступны по запросу

根据要求提供其它尺寸

codice singoli spessori
code individual thicknesses

misura	cod. OMS	codice originale
1,00	02-20-017/100	-
1,01	02-20-01/101	-
1,03	02-20-017/103	-
1,05	02-20-017/105	-
1,07	02-20-017/107	-
1,09	02-20-017/109	-
1,11	02-20-017/111	1 410 067 304
1,13	02-20-017/113	1 410 067 306
1,15	02-20-017/115	1 410 067 308
1,17	02-20-017/117	1 410 067 310
1,19	02-20-017/119	1 410 067 312
1,21	02-20-017/121	1 410 067 314
1,23	02-20-017/123	1 410 067 316
1,25	02-20-017/125	1 410 067 318
1,27	02-20-017/127	1 410 067 320
1,29	02-20-017/129	1 410 067 322
1,31	02-20-017/131	1 410 067 324
1,33	02-20-017/133	1 410 067 326
1,35	02-20-017/135	1 410 067 328
1,37	02-20-017/137	1 410 067 330
1,39	02-20-017/139	1 410 067 332
1,41	02-20-017/141	1 410 067 334
1,43	02-20-017/143	1 410 067 336
1,45	02-20-017/145	1 410 067 338

Codice OMS	Spessore	Incremento	n° pezzi
02-20-017	da 1,00 a 1,45	0,02	240



valigetta 24 posizioni
handbag 24 position



BOSCH

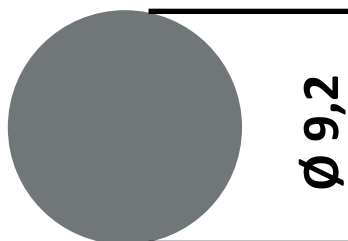

da 1,00.. a 1,45

ALTRE MISURE DISPONIBILI A RICHIESTA

Other sizes available upon request

Otros tamaños disponibles bajo petición

Другие размеры доступны по запросу

根据要求提供其它尺寸

codice singoli spessori
code individual thicknesses

misura	cod. OMS
1,00	02-31-100
1,01	02-31-101
1,03	02-31-103
1,05	02-31-105
1,07	02-31-107
1,09	02-31-109
1,11	02-31-111
1,13	02-31-113
1,15	02-31-115
1,17	02-31-117
1,19	02-31-119
1,21	02-31-121
1,23	02-31-123
1,25	02-31-125
1,27	02-31-127
1,29	02-31-129
1,31	02-31-131
1,33	02-31-133
1,35	02-31-135
1,37	02-31-137
1,39	02-31-139
1,41	02-31-141
1,43	02-31-143
1,45	02-31-145

Codice OMS	Spessore	Incremento	n° pezzi
02-20-011	da 1,00 a 1,45	0,02	240



valigetta 24 posizioni



BOSCH E VARI

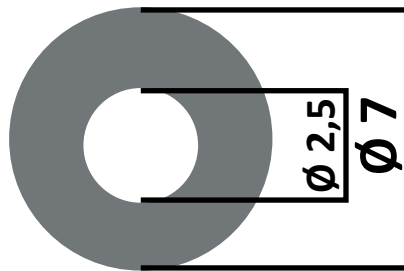

da 0,80.. a 2,00

ALTRE MISURE DISPONIBILI A RICHIESTA

Other sizes available upon request

Otros tamaños disponibles bajo petición

Другие размеры доступны по запросу

根据要求提供其它尺寸

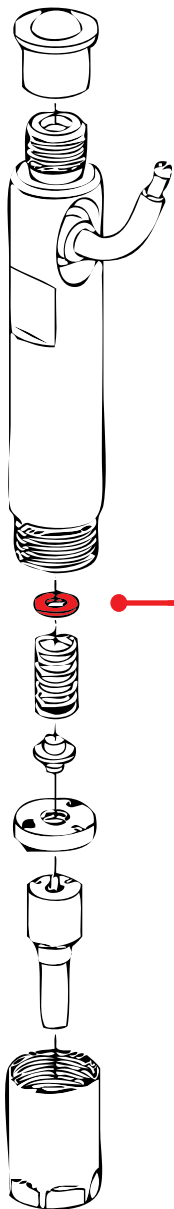

Codice OMS	Spessore	Incremento	n° pezzi
02-20-007	da 0,80 a 1,95	0,05	480



valigetta 24 posizioni

Codice OMS	Spessore	Incremento	n° pezzi
02-20-019	da 0,80 a 2,00	0,02	1220



valigetta 96 posizioni



BOSCH E VARI

codice singoli spessori code individual thicknesses		
misura	cod. OMS	rif. originale
0,80	02-13-001	-
0,82	02-13-031	-
0,84	02-13-032	-
0,85	02-13-002	-
0,86	02-13-033	-
0,88	02-13-034	-
0,90	02-13-003	-
0,92	02-13-035	-
0,94	02-13-036	-
0,95	02-13-004	-
0,96	02-13-037	-
0,98	02-13-038	-
1,00	02-13-005	2 430 102 100
1,02	02-13-039	2 430 102 102
1,04	02-13-040	2 430 102 104
1,05	02-13-006	2 430 102 105
1,06	02-13-041	2 430 102 106
1,08	02-13-042	2 430 102 108
1,10	02-13-007	2 430 102 110
1,12	02-13-043	2 430 102 112
1,14	02-13-044	2 430 102 114
1,15	02-13-008	2 430 102 115
1,16	02-13-045	2 430 102 116
1,18	02-13-046	2 430 102 118
1,20	02-13-009	2 430 102 120
1,22	02-13-047	2 430 102 122
1,24	02-13-048	2 430 102 124
1,25	02-13-010	2 430 102 125
1,26	02-13-049	2 430 102 126
1,28	02-13-050	2 430 102 128
1,30	02-13-011	2 430 102 130
1,32	02-13-051	2 430 102 132
1,34	02-13-052	2 430 102 134
1,35	02-13-012	2 430 102 135
1,36	02-13-053	2 430 102 136
1,38	02-13-054	2 430 102 138
1,40	02-13-013	2 430 102 140

codice singoli spessori code individual thicknesses		
misura	cod. OMS	rif. originale
1,42	02-13-055	2 430 102 142
1,44	02-13-056	2 430 102 144
1,45	02-13-014	2 430 102 145
1,46	02-13-057	2 430 102 146
1,48	02-13-058	2 430 102 148
1,50	02-13-015	2 430 102 150
1,52	02-13-059	2 430 102 152
1,54	02-13-060	2 430 102 154
1,55	02-13-016	2 430 102 155
1,56	02-13-061	2 430 102 156
1,58	02-13-062	2 430 102 158
1,60	02-13-017	2 430 102 160
1,62	02-13-063	2 430 102 162
1,64	02-13-064	2 430 102 164
1,65	02-13-018	2 430 102 165
1,66	02-13-065	2 430 102 166
1,68	02-13-066	2 430 102 168
1,70	02-13-019	2 430 102 170
1,72	02-13-067	2 430 102 172
1,74	02-13-068	2 430 102 174
1,75	02-13-020	2 430 102 175
1,76	02-13-069	2 430 102 176
1,78	02-13-070	2 430 102 178
1,80	02-13-021	2 430 102 180
1,82	02-13-071	2 430 102 182
1,84	02-13-072	2 430 102 184
1,85	02-13-022	2 430 102 185
1,86	02-13-073	2 430 102 186
1,88	02-13-074	2 430 102 188
1,90	02-13-023	2 430 102 190
1,92	02-13-075	2 430 102 192
1,94	02-13-076	2 430 102 194
1,95	02-13-024	2 430 102 195
1,96	02-13-077	2 430 102 196
1,98	02-13-078	2 430 102 198
2,00	02-13-025	-



Via piave, 15-25015 Desenzano del Garda (Brescia) Italia Tel. +39 030 9127051 - +39 030 9127052 - Fax +39 030 9124070



BOSCH Doppia Molla

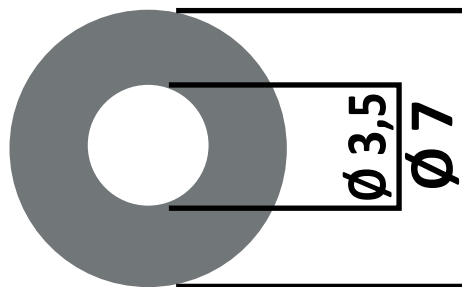
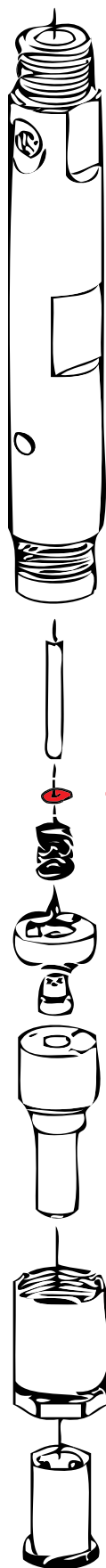

da 0,10.. a 2,00

ALTRE MISURE DISPONIBILI A RICHIESTA

Other sizes available upon request
Otros tamaños disponibles bajo petición
Другие размеры доступны по запросу
根据要求提供其它尺寸

codice singoli spessori
code individual
thicknesses

misura	cod. OMS
0,10	02-14-027
0,20	02-14-028
0,30	02-14-029
0,40	02-14-084
0,50	02-14-030
0,80	02-14-001
0,82	02-14-031
0,84	02-14-032
0,85	02-14-002
0,86	02-14-033
0,88	02-14-034
0,90	02-14-003
0,92	02-14-035
0,94	02-14-036
0,95	02-14-004
0,96	02-14-037
0,98	02-14-038
1,00	02-14-005
1,02	02-14-039
1,04	02-14-040
1,05	02-14-006
1,06	02-14-041
1,08	02-14-042
1,10	02-14-007
1,12	02-14-043
1,14	02-14-044
1,15	02-14-008
1,16	02-14-045
1,18	02-14-046
1,20	02-14-009
1,22	02-14-047
1,24	02-14-048
1,25	02-14-010
1,26	02-14-049
1,28	02-14-050
1,30	02-14-011
1,32	02-14-051
1,34	02-14-052
1,35	02-14-012

codice singoli spessori
code individual
thicknesses

misura	cod. OMS
1,36	02-14-053
1,38	02-14-054
1,40	02-14-013
1,42	02-14-055
1,44	02-14-056
1,45	02-14-014
1,46	02-14-057
1,48	02-14-058
1,50	02-14-015
1,52	02-14-059
1,54	02-14-060
1,55	02-14-016
1,56	02-14-061
1,58	02-14-062
1,60	02-14-017
1,62	02-14-063
1,64	02-14-064
1,65	02-14-018
1,66	02-14-065
1,68	02-14-066
1,70	02-14-019
1,72	02-14-067
1,74	02-14-068
1,75	02-14-020
1,76	02-14-069
1,78	02-14-070
1,80	02-14-021
1,82	02-14-071
1,84	02-14-072
1,85	02-14-022
1,86	02-14-073
1,88	02-14-074
1,90	02-14-023
1,92	02-14-075
1,94	02-14-076
1,95	02-14-024
1,96	02-14-077
1,98	02-14-078
2,00	02-14-025

Codice OMS	Spessore	Incremento	n° pezzi
02-20-006	da 0,80 a 1,95	0,05	480



valigetta 24 posizioni

Codice OMS	Spessore	Incremento	n° pezzi
02-20-020	da 0,80 a 2,00	0,02	1220



valigetta 96 posizioni



BOSCH E VARI

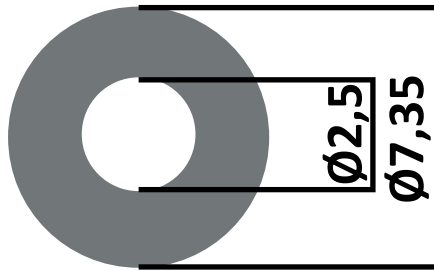
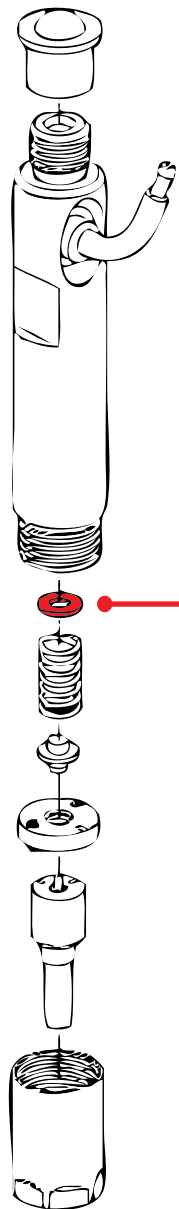

da 0,05.. a 2,00

ALTRE MISURE DISPONIBILI A RICHIESTA

Other sizes available upon request

Otros tamaños disponibles bajo petición

Другие размеры доступны по запросу

根据要求提供其它尺寸

Codice OMS	Spessore	Incremento	n° pezzi
02-20-005	da 0,80 a 1,95	0,05	480



valigetta 24 posizioni

Codice OMS	Spessore	Incremento	n° pezzi
02-20-021	da 0,80 a 2,00	0,02	1220



valigetta 96 posizioni



BOSCH E VARI

codice singoli spessori code individual thicknesses		
misura	cod. OMS	rif. originale
0,05	02-15-026	-
0,10	02-15-027	-
0,20	02-15-028	-
0,30	02-15-029	-
0,50	02-15-030	-
0,80	02-15-001	-
0,85	02-15-002	-
0,90	02-15-003	-
0,95	02-15-004	-
1,00	02-15-005	2 430 102 400
1,02	02-15-039	2 430 101 036
1,02		2 430 102 402
1,04	02-15-040	2 430 101 037
1,04		2 430 102 404
1,06	02-15-041	2 430 101 038
1,06		2 430 102 406
1,08	02-15-042	2 430 101 039
1,08		2 430 102 408
1,10	02-15-007	2 430 101 040
1,10		2 430 102 410
1,12	02-15-043	2 430 101 041
1,12		2 430 102 412
1,14	02-15-044	2 430 101 042
1,14		2 430 102 414
1,16	02-15-045	2 430 101 043
1,16		2 430 102 416
1,18	02-15-046	2 430 101 044
1,18		2 430 102 418
1,20	02-15-009	2 430 101 045
1,20		2 430 102 420
1,22	02-15-047	2 430 101 046
1,22		2 430 102 422
1,24	02-15-048	2 430 101 047
1,24		2 430 102 424
1,26	02-15-049	2 430 101 048
1,26		2 430 102 426
1,28	02-15-050	2 430 101 049
1,28		2 430 102 428
1,30	02-15-011	2 430 101 050
1,30		2 430 102 430
1,32	02-15-051	2 430 101 051
1,32		2 430 102 432

codice singoli spessori code individual thicknesses		
misura	cod. OMS	rif. originale
1,34	02-15-052	2 430 101 052
1,34		2 430 102 434
1,35	02-15-012	-
1,36	02-15-053	2 430 101 053
1,36		2 430 102 436
1,38	02-15-054	2 430 101 054
1,38		2 430 102 438
1,40	02-15-013	2 430 101 055
1,40		2 430 102 440
1,42	02-15-055	2 430 101 056
1,42		2 430 102 442
1,44	02-15-056	2 430 101 057
1,44		2 430 102 444
1,45	02-15-014	-
1,46	02-15-057	2 430 101 058
1,46		2 430 102 446
1,48	02-15-058	2 430 101 059
1,48		2 430 102 448
1,50	02-15-015	2 430 101 060
1,50		2 430 102 450
1,52	02-15-059	2 430 101 061
1,52		2 430 102 452
1,54	02-15-060	2 430 101 062
1,54		2 430 102 454
1,55	02-15-016	-
1,56	02-15-061	2 430 101 063
1,56		2 430 102 456
1,58	02-15-062	2 430 101 064
1,58		2 430 102 458
1,60	02-15-017	2 430 101 065
1,60		2 430 102 460
1,62	02-15-063	2 430 101 066
1,62		2 430 102 462
1,64	02-15-064	2 430 101 067
1,64		2 430 102 464
1,65	02-15-018	-
1,66	02-15-065	2 430 101 068
1,66		2 430 102 466
1,68	02-15-066	2 430 101 069
1,68		2 430 102 468
1,70	02-15-019	2 430 101 070
1,70		2 430 102 470



BOSCH E VARI

codice singoli spessori code individual thicknesses		
misura	cod. OMS	rif. originale
1,72	02-15-067	2 430 101 071
1,72		2 430 102 472
1,74	02-15-068	2 430 101 072
1,74		2 430 102 474
1,75	02-15-020	-
1,76	02-15-069	2 430 101 073
1,76		2 430 102 476
1,78	02-15-070	2 430 101 074
1,78		2 430 102 478
1,80	02-15-021	2 430 101 075
1,80		2 430 102 480
1,82	02-15-071	2 430 101 076
1,82		2 430 102 482
1,84	02-15-072	2 430 101 077
1,84		2 430 102 484
1,86	02-15-073	2 430 101 078
1,86		2 430 102 486
1,88	02-15-074	2 430 101 079
1,88		2 430 102 488
1,90	02-15-023	2 430 101 080
1,90		2 430 102 490
1,92	02-15-075	2 430 101 081
1,92		2 430 102 492
1,94	02-15-076	2 430 101 082
1,94		2 430 102 494
1,95	02-15-024	-
1,96	02-15-077	2 430 101 083
1,96		2 430 102 496
1,98	02-15-078	2 430 102 498
2,00	02-15-025	-



BOSCH E VARI

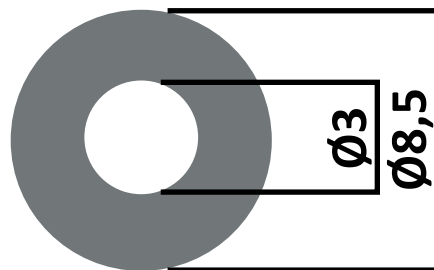
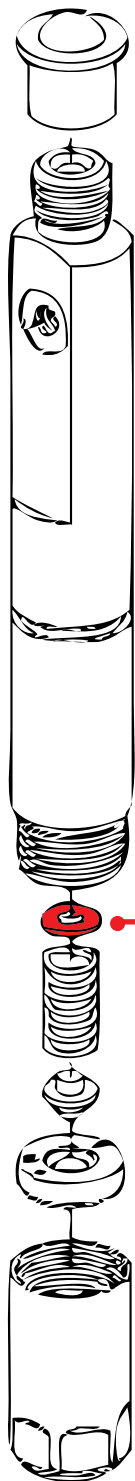

da 0,05... a 2,00

ALTRE MISURE DISPONIBILI A RICHIESTA

Other sizes available upon request
Otros tamaños disponibles bajo petición
Другие размеры доступны по запросу
根据要求提供其它尺寸

Codice OMS	Spessore	Incremento	n° pezzi
02-20-004	da 0,80 a 1,95	0,05	480



valigetta 24 posizioni

Codice OMS	Spessore	Incremento	n° pezzi
02-20-022	da 0,80 a 2,00	0,02	1220



valigetta 96 posizioni



BOSCH E VARI

codice singoli spessori code individual thicknesses		
misura	cod. OMS	rif. originale
0,05	02-16-026	-
0,10	02-16-027	-
0,20	02-16-028	-
0,30	02-16-029	-
0,50	02-16-030	-
0,80	02-16-001	-
0,85	02-16-002	-
0,90	02-16-003	-
0,95	02-16-004	-
1,00	02-16-005	2 430 101 800
1,02	02-16-039	2 430 101 801
1,04	02-16-040	2 430 101 802
1,05	02-16-006	-
1,06	02-16-041	2 430 101 803
1,08	02-16-042	2 430 101 804
1,10	02-16-007	2 430 101 805
1,12	02-16-043	2 430 101 806
1,14	02-16-044	2 430 101 807
1,15	02-16-008	-
1,16	02-16-045	2 430 101 808
1,18	02-16-046	2 430 101 809
1,20	02-16-009	2 430 101 810
1,22	02-16-047	2 430 101 811
1,24	02-16-048	2 430 101 812
1,25	02-16-010	-
1,26	02-16-049	2 430 101 813
1,28	02-16-050	2 430 101 814
1,30	02-16-011	2 430 101 815
1,32	02-16-051	2 430 101 816
1,34	02-16-052	2 430 101 817
1,35	02-16-012	-
1,36	02-16-053	2 430 101 818
1,38	02-16-054	2 430 101 819
1,40	02-16-013	2 430 101 820
1,42	02-16-055	2 430 101 821
1,44	02-16-056	2 430 101 822
1,45	02-16-014	-
1,46	02-16-057	2 430 101 823
1,48	02-16-058	2 430 101 824
1,50	02-16-015	2 430 101 825
1,52	02-16-059	2 430 101 826
1,54	02-16-060	2 430 101 827
1,55	02-16-016	-
1,56	02-16-061	2 430 101 828
1,58	02-16-062	2 430 101 829

codice singoli spessori code individual thicknesses		
misura	cod. OMS	rif. originale
1,60	02-16-017	2 430 101 830
1,62	02-16-063	2 430 101 831
1,64	02-16-064	2 430 101 832
1,65	02-16-018	-
1,66	02-16-065	2 430 101 833
1,68	02-16-066	2 430 101 834
1,70	02-16-019	2 430 101 835
1,72	02-16-067	2 430 101 836
1,74	02-16-068	2 430 101 837
1,75	02-16-020	-
1,76	02-16-069	2 430 101 838
1,78	02-16-070	2 430 101 839
1,80	002-16-021	2 430 101 840
1,82	02-16-071	2 430 101 841
1,84	02-16-072	2 430 101 842
1,85	02-16-022	-
1,86	02-16-073	2 430 101 843
1,88	02-16-074	2 430 101 844
1,90	02-16-023	2 430 101 845
1,92	02-16-075	2 430 101 846
1,94	02-16-076	2 430 101 847
1,95	02-16-024	-
1,96	02-16-077	2 430 101 848
1,98	02-16-078	2 430 101 849
2,00	002-16-025	-



BOSCH E VARI

da 0,05.. a 2,00

ALTRE MISURE DISPONIBILI A RICHIESTA

Other sizes available upon request

Otros tamaños disponibles bajo petición

Другие размеры доступны по запросу

根据要求提供其它尺寸

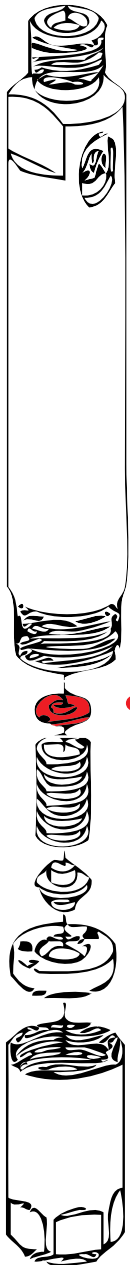
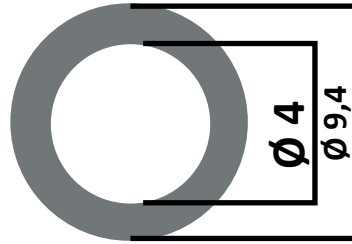

codice singoli spessori code individual thicknesses		codice singoli spessori code individual thicknesses	
misura	cod. OMS	misura	cod. OMS
0,05	02-17-026	1,36	02-17-053
0,10	02-17-027	1,38	02-17-054
0,20	02-17-028	1,40	02-17-013
0,30	02-17-029	1,42	02-17-055
0,50	02-17-030	1,44	02-17-056
0,80	02-17-001	1,45	02-17-014
0,82	02-17-031	1,46	02-17-057
0,84	02-17-032	1,48	02-17-058
0,85	02-17-002	1,50	02-17-015
0,86	02-17-033	1,52	02-17-059
0,88	02-17-034	1,54	02-17-060
0,90	02-17-003	1,55	02-17-016
0,92	02-17-035	1,56	02-17-061
0,94	02-17-036	1,58	02-17-062
0,95	02-17-004	1,60	02-17-017
0,96	02-17-037	1,62	02-17-063
0,98	02-17-038	1,64	02-17-064
1,00	02-17-005	1,65	02-17-018
1,02	02-17-039	1,66	02-17-065
1,04	02-17-040	1,68	02-17-066
1,05	02-17-006	1,70	02-17-019
1,06	02-17-041	1,72	02-17-067
1,08	02-17-042	1,74	02-17-068
1,10	02-17-007	1,75	02-17-020
1,12	02-17-043	1,76	02-17-069
1,14	02-17-044	1,78	02-17-070
1,15	02-17-008	1,80	02-17-021
1,16	02-17-045	1,82	02-17-071
1,18	02-17-046	1,84	02-17-072
1,20	02-17-009	1,85	02-17-022
1,22	02-17-047	1,86	02-17-073
1,24	02-17-048	1,88	02-17-074
1,25	02-17-010	1,90	02-17-023
1,26	02-17-049	1,92	02-17-075
1,28	02-17-050	1,94	02-17-076
1,30	02-17-011	1,95	02-17-024
1,32	02-17-051	1,96	02-17-077
1,34	02-17-052	1,98	02-17-078
1,35	02-17-012	2,00	02-17-025

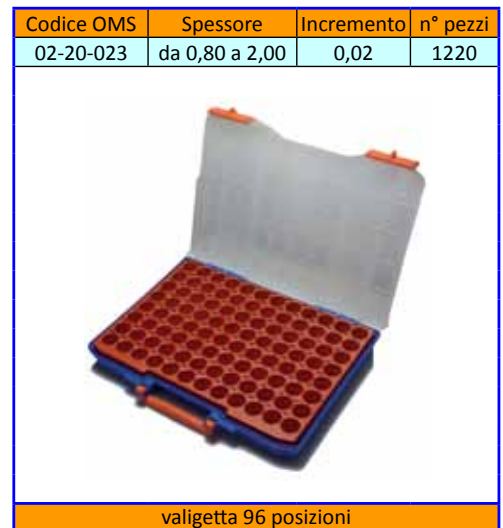



Via piave,15-25015 Desenzano del Garda (Brescia) Italia Tel.+39 030 9127051 - +39 030 9127052 - Fax +39 030 9124070



BOSCH E VARI

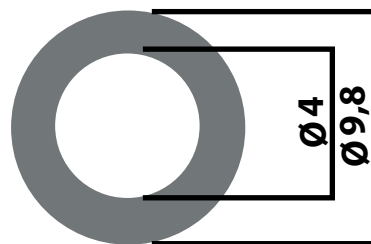

da 0,05.. a 2,00

ALTRE MISURE DISPONIBILI A RICHIESTA

Other sizes available upon request
Otros tamaños disponibles bajo petición
Другие размеры доступны по запросу
根据要求提供其它尺寸



Codice OMS	Spessore	Incremento	n° pezzi
02-20-002	da 0,80 a 1,95	0,05	480



valigetta 24 posizioni

Codice OMS	Spessore	Incremento	n° pezzi
02-20-024	da 0,80 a 2,00	0,02	1220



valigetta 96 posizioni



BOSCH E VARI

codice singoli spessori code individual thicknesses		
misura	cod. OMS	rif. originale
0,05	02-18-026	-
0,10	02-18-027	-
0,20	02-18-028	-
0,30	02-18-029	-
0,50	02-18-030	-
0,80	02-18-001	2 430 101 500
0,82	02-18-031	2 430 101 501
0,84	02-18-032	2 430 101 502
0,85	02-18-002	-
0,86	02-18-033	2 430 101 503
0,88	02-18-034	2 430 101 504
0,90	02-18-003	2 430 101 505
0,92	02-18-035	2 430 101 506
0,94	02-18-036	2 430 101 507
0,95	02-18-004	-
0,96	02-18-037	2 430 101 508
0,98	02-18-038	2 430 101 509
1,00	02-18-005	2 430 101 510
1,00		2 430 101 170
1,02	02-18-039	2 430 101 511
1,02		2 430 101 171
1,04	02-18-040	2 430 101 512
1,04		2 430 101 172
1,05	02-18-006	-
1,06	02-18-041	2 430 101 513
1,06		2 430 101 173
1,08	02-18-042	2 430 101 514
1,08		2 430 101 174
1,10	02-18-007	2 430 101 515
1,10		2 430 101 175
1,12	02-18-043	2 430 101 516
1,12		2 430 101 176
1,14	02-18-044	2 430 101 517
1,14		2 430 101 177
1,15	02-18-008	-
1,16	02-18-045	2 430 101 518
1,16		2 430 101 178
1,18	02-18-046	2 430 101 519
1,18		2 430 101 179
1,20	02-18-009	2 430 101 520
1,20		2 430 101 180
1,22	02-18-047	2 430 101 521
1,22		2 430 101 181
1,24	02-18-048	2 430 101 522
1,24		2 430 101 182
1,25	02-18-010	-
1,26	02-18-049	2 430 101 523
1,26		2 430 101 183
1,28	02-18-050	2 430 101 524
1,28		2 430 101 184

codice singoli spessori code individual thicknesses		
misura	cod. OMS	rif. originale
1,30	02-18-011	2 430 101 525
1,30		2 430 101 185
1,32	02-18-051	2 430 101 526
1,32		2 430 101 186
1,34	02-18-052	2 430 101 527
1,34		2 430 101 187
1,35	02-18-012	-
1,36	02-18-053	2 430 101 528
1,36		2 430 101 188
1,38	02-18-054	2 430 101 529
1,38		2 430 101 189
1,40	02-18-013	2 430 101 530
1,40		2 430 101 190
1,42	02-18-055	2 430 101 531
1,44	02-18-056	2 430 101 532
1,45	02-18-014	-
1,46	02-18-057	2 430 101 533
1,48	02-18-058	2 430 101 534
1,50	02-18-015	2 430 101 535
1,52	02-18-059	2 430 101 536
1,54	02-18-060	2 430 101 537
1,55	02-18-016	-
1,56	02-18-061	2 430 101 538
1,58	02-18-062	2 430 101 539
1,60	02-18-017	2 430 101 540
1,62	02-18-063	2 430 101 541
1,64	02-18-064	2 430 101 542
1,65	02-18-018	-
1,66	02-18-065	2 430 101 543
1,68	02-18-066	2 430 101 544
1,70	02-18-019	2 430 101 545
1,72	02-18-067	2 430 101 546
1,74	02-18-068	2 430 101 547
1,75	02-18-020	-
1,76	02-18-069	2 430 101 548
1,78	02-18-070	2 430 101 549
1,80	02-18-021	2 430 101 550
1,82	02-18-071	2 430 101 551
1,84	02-18-072	2 430 101 552
1,85	02-18-022	-
1,86	02-18-073	2 430 101 553
1,88	02-18-074	2 430 101 554
1,90	02-18-023	2 430 101 555
1,92	02-18-075	2 430 101 556
1,94	02-18-076	2 430 101 557
1,95	02-18-024	-
1,96	02-18-077	2 430 101 558
1,98	02-18-078	2 430 101 559
2,00	02-18-025	-



BOSCH E VARI

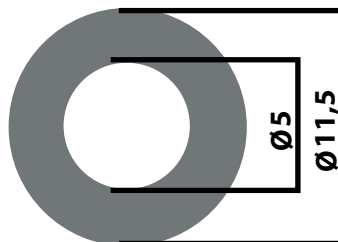

da 0,05.. a 2,00

ALTRE MISURE DISPONIBILI A RICHIESTA

Other sizes available upon request

Otros tamaños disponibles bajo petición

Другие размеры доступны по запросу

根据要求提供其它尺寸

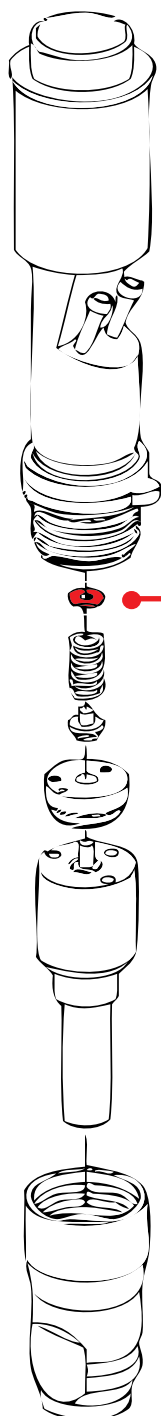

Codice OMS	Spessore	Incremento	n° pezzi
02-20-001	da 0,80 a 1,95	0,05	480



valigetta 24 posizioni

Codice OMS	Spessore	Incremento	n° pezzi
02-20-025	da 0,80 a 2,00	0,02	1220



valigetta 96 posizioni





BOSCH E VARI

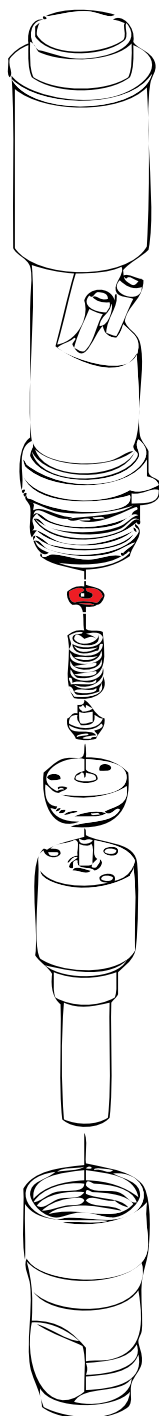

codice singoli spessori code individual thicknesses		
misura	cod. OMS	rif. originale
0,05	02-19-026	-
0,10	02-19-027	-
0,20	02-19-028	-
0,30	02-19-029	-
0,50	02-19-030	-
0,80	02-19-001	2 430 100 525
0,80		2 430 102 880
0,82	02-19-031	2 430 100 526
0,82		2 430 102 882
0,84	02-19-032	2 430 102 884
0,84		2 430 100 527
0,85	02-19-002	-
0,86	02-19-033	2 430 100 528
0,86		2 430 102 886
0,88	02-19-034	2 430 102 888
0,88		2 430 100 529
0,90	02-19-003	2 430 102 890
0,90		2 430 100 530
0,92	02-19-035	2 430 102 892
0,92		2 430 100 531
0,94	02-19-036	2 430 100 432
0,94		2 430 102 894
0,95	02-19-004	-
0,96	02-19-037	2 430 102 896
0,96		2 430 100 533
0,98	02-19-038	2 430 102 898
0,98		2 430 100 534
1,00	02-19-005	2 430 102 900
1,00		2 430 100 535
1,02	02-19-039	2 430 102 902
1,02		2 430 100 536
1,04	02-19-040	2 430 102 904
1,04		2 430 100 537
1,05	02-19-006	-
1,06	02-19-041	2 430 102 906
1,06		2 430 100 538
1,08	02-19-042	2 430 102 908
1,08		2 430 100 539
1,10	02-19-007	2 430 100 540
1,10		2 430 102 910
1,12	02-19-043	2 430 102 912
1,12		2 430 100 541
1,14	02-19-044	2 430 102 914
1,14		2 430 100 542
1,15	02-19-008	-
1,16	02-19-045	2 430 102 916
1,16		2 430 100 543

codice singoli spessori code individual thicknesses		
misura	cod. OMS	rif. originale
1,18	02-19-046	2 430 102 918
1,18		2 430 100 544
1,20	02-19-009	2 430 102 920
1,20		2 430 100 545
1,22	02-19-047	2 430 102 922
1,22		2 430 100 546
1,22		2 430 100 548
1,24	02-19-048	2 430 102 924
1,24		2 430 100 547
1,25	02-19-010	-
1,26	02-19-049	2 430 102 926
1,28	02-19-050	2 430 102 928
1,28		2 430 100 549
1,30	02-19-011	2 430 102 930
1,30		2 430 100 550
1,32	02-19-051	2 430 102 932
1,32		2 430 100 551
1,34	02-19-052	2 430 102 934
1,34		2 430 100 552
1,35	02-19-012	-
1,36	02-19-053	2 430 102 936
1,36		2 430 100 553
1,38	02-19-054	2 430 102 938
1,38		2 430 100 554
1,40	02-19-013	2 430 102 940
1,40		2 430 100 555
1,42	02-19-055	2 430 100 556
1,42		2 430 102 942
1,44	02-19-056	2 430 102 944
1,44		2 430 100 557
1,45	02-19-014	-
1,46	02-19-057	2 430 102 946
1,46		2 430 100 558
1,48	02-19-058	2 430 102 948
1,48		2 430 100 559
1,50	02-19-015	2 430 102 950
1,50		2 430 100 560
1,52	02-19-059	2 430 102 952
1,52		2 430 100 561
1,54	02-19-060	2 430 102 954
1,54		2 430 100 562
1,55	02-19-016	-
1,56	02-19-061	2 430 102 956
1,56		2 430 100 563
1,58	02-19-062	2 430 102 958
1,58		2 430 100 564



BOSCH E VARI

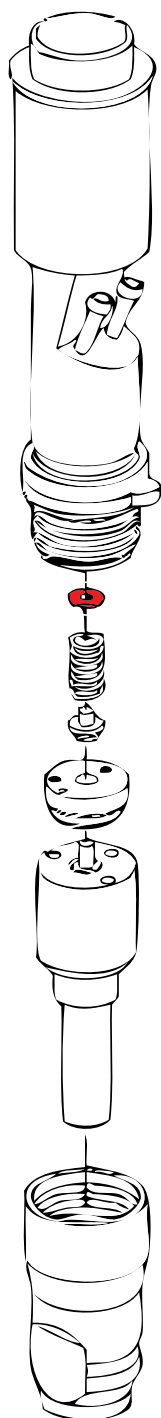

codice singoli spessori code individual thicknesses		
misura	cod. OMS	rif. originale
1,60	02-19-017	2 430 102 960
1,60		2 430 100 565
1,62	02-19-063	2 430 102 962
1,62		2 430 100 566
1,64	02-19-064	2 430 102 964
1,64		2 430 100 567
1,65	02-19-018	-
1,66	02-19-065	2 430 102 966
1,66		2 430 100 568
1,68	02-19-066	2 430 102 968
1,68		2 430 100 569
1,70	02-19-019	2 430 102 970
1,70		2 430 100 570
1,72	02-19-067	2 430 102 972
1,72		2 430 100 571
1,74	02-19-068	2 430 102 974
1,74		2 430 100 572
1,75	02-19-020	-
1,76	02-19-069	2 430 102 976
1,76		2 430 100 573
1,78	02-19-070	2 430 102 978
1,78		2 430 100 574
1,80	02-19-021	2 430 102 980
1,80		2 430 100 575
1,82	02-19-071	2 430 102 982
1,82		2 430 100 576
1,84	02-19-072	2 430 102 984
1,84		2 430 100 577
1,85	02-19-022	-
1,86	02-19-073	2 430 102 986
1,86		2 430 100 578
1,88	02-19-074	2 430 102 988
1,88		2 430 100 579
1,90	02-19-023	2 430 102 990
1,90		2 430 100 580
1,92	02-19-075	2 430 102 992
1,92		2 430 100 581
1,94	02-19-076	2 430 102 994
1,94		2 430 100 582
1,95	02-19-024	-
1,96	02-19-077	2 430 102 996
1,96		2 430 100 583
1,98	02-19-078	2 430 102 998
1,98		2 430 100 584
2,00	02-19-025	-



BOSCH E VARI

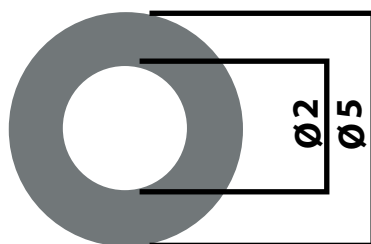

da 0,80.. a 2,00

ALTRE MISURE DISPONIBILI A RICHIESTA

Other sizes available upon request

Otros tamaños disponibles bajo petición

Другие размеры доступны по запросу

根据要求提供其它尺寸

codice singoli spessori
code individual thicknesses

misura	cod. OMS
0,80	02-12-001
0,82	02-12-031
0,84	02-12-032
0,85	02-12-002
0,86	02-12-033
0,88	02-12-034
0,90	02-12-003
0,92	02-12-035
0,94	02-12-036
0,95	02-12-004
0,96	02-12-037
0,98	02-12-038
1,00	02-12-005
1,02	02-12-039
1,04	02-12-040
1,05	02-12-006
1,06	02-12-041
1,08	02-12-042
1,10	02-12-007
1,12	02-12-043
1,14	02-12-044
1,15	02-12-008
1,16	02-12-045
1,18	02-12-046
1,20	02-12-009
1,22	02-12-047
1,24	02-12-048
1,25	02-12-010
1,26	02-12-049
1,28	02-12-050
1,30	02-12-011
1,32	02-12-051
1,34	02-12-052
1,35	02-12-012
1,36	02-12-053
1,38	02-12-054
1,40	02-12-013

codice singoli spessori
code individual thicknesses

misura	cod. OMS
1,42	02-12-055
1,44	02-12-056
1,45	02-12-014
1,46	02-12-057
1,48	02-12-058
1,50	02-12-015
1,52	02-12-059
1,54	02-12-060
1,55	02-12-016
1,56	02-12-061
1,58	02-12-062
1,60	02-12-017
1,62	02-12-063
1,64	02-12-064
1,65	02-12-018
1,66	02-12-065
1,68	02-12-066
1,70	02-12-019
1,72	02-12-067
1,74	02-12-068
1,75	02-12-020
1,76	02-12-069
1,78	02-12-070
1,80	02-12-021
1,82	02-12-071
1,84	02-12-072
1,85	02-12-022
1,86	02-12-073
1,88	02-12-074
1,90	02-12-023
1,92	02-12-075
1,94	02-12-076
1,95	02-12-024
1,96	02-12-077
1,98	02-12-078
2,00	02-12-025

Codice OMS	Spessore	Incremento	n° pezzi
02-20-008	da 0,80 a 1,95	0,05	480



valigetta 24 posizioni

Codice OMS	Spessore	Incremento	n° pezzi
02-20-026	da 0,80 a 2,00	0,02	1220



valigetta 96 posizioni



VARI

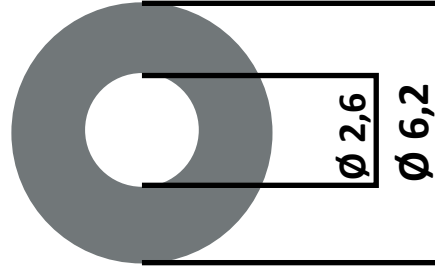

da 0,40 ... a 1,20

ALTRE MISURE DISPONIBILI A RICHIESTA

Other sizes available upon request

Otros tamaños disponibles bajo petición

Другие размеры доступны по запросу

根据要求提供其它尺寸

codice singoli spessori
code individual thicknesses

misura	cod. OMS
0,40	02-35-040
0,50	02-35-050
0,52	02-35-052
0,54	02-35-054
0,56	02-35-056
0,58	02-35-058
0,60	02-35-060
0,70	02-35-070
1,20	02-35-120



VARI

da 0,50.. a 1,98

ALTRE MISURE DISPONIBILI A RICHIESTA

Other sizes available upon request
Otros tamaños disponibles bajo petición
Другие размеры доступны по запросу
根据要求提供其它尺寸

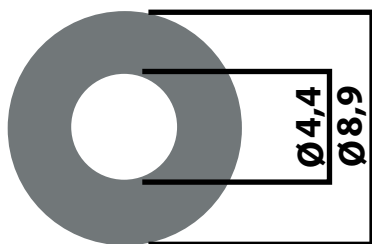

codice singoli code individual	
misura	cod. OMS
0,50	02-30-050
0,52	02-30-052
0,54	02-30-054
0,56	02-30-056
0,58	02-30-058
0,60	02-30-060
0,62	02-30-062
0,64	02-30-064
0,66	02-30-066
0,68	02-30-068
0,70	02-30-070
0,72	02-30-072
0,74	02-30-074
0,76	02-30-076
0,78	02-30-078
0,80	02-30-080
0,82	02-30-082
0,84	02-30-084
0,86	02-30-086
0,88	02-30-088
0,90	02-30-090
0,92	02-30-092
0,94	02-30-094
0,96	02-30-096
0,98	02-30-098
1,00	02-30-100
1,02	02-30-102
1,04	02-30-104
1,06	02-30-106
1,08	02-30-108
1,12	02-30-112
1,14	02-30-114
1,16	02-30-116
1,18	02-30-118
1,20	02-30-120
1,22	02-30-122
1,24	02-30-124

codice singoli code individual	
misura	cod. OMS
1,26	02-30-126
1,28	02-30-128
1,30	02-30-130
1,32	02-30-132
1,34	02-30-134
1,36	02-30-136
1,38	02-30-138
1,40	02-30-140
1,42	02-30-142
1,44	02-30-144
1,46	02-30-146
1,48	02-30-148
1,50	02-30-150
1,52	02-30-152
1,54	02-30-154
1,56	02-30-156
1,58	02-30-158
1,60	02-30-160
1,62	02-30-162
1,64	02-30-164
1,66	02-30-166
1,68	02-30-168
1,70	02-30-170
1,72	02-30-172
1,74	02-30-174
1,76	02-30-176
1,78	02-30-178
1,80	02-30-180
1,82	02-30-182
1,84	02-30-184
1,86	02-30-186
1,88	02-30-188
1,90	02-30-190
1,92	02-30-192
1,94	02-30-194
1,96	02-30-196
1,98	02-30-198



BOSCH DENSO POMPA ROTATIVA

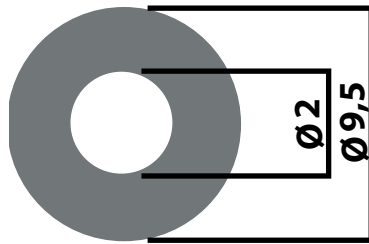
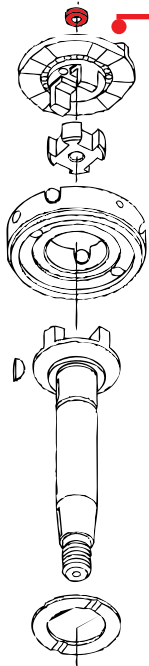

da 1,78.. a 2,90

ALTRE MISURE DISPONIBILI A RICHIESTA

Other sizes available upon request
Otros tamaños disponibles bajo petición
Другие размеры доступны по запросу
根据要求提供其它尺寸

codice singoli code individual		
misura	rif. originale	cod. OMS
1,78	1 460 100 708	02-33-178
1,80	1 460 100 709	02-22-180
1,82	1 460 100 710	02-33-182
1,84	1 460 100 711	02-33-184
1,86	1 460 100 712	02-33-186
1,88	1 460 100 713	02-33-188
1,90	1 460 100 657	02-33-190
1,92	1 460 100 658	02-33-192
1,94	1 460 100 659	02-33-194
1,96	1 460 100 660	02-33-196
1,98	1 460 100 661	02-33-198
2,00	1 460 100 662	02-33-200
2,02	1 460 100 663	02-33-202
2,04	1 460 100 664	02-33-204
2,06	1 460 100 665	02-33-206
2,08	1 460 100 666	02-33-208
2,10	1 460 100 667	02-33-210
2,12	1 460 100 668	02-33-212
2,14	1 460 100 669	02-33-214
2,16	1 460 100 670	02-33-216
2,18	1 460 100 671	02-33-218
2,20	1 460 100 672	02-33-220
2,22	1 460 100 673	02-33-222
2,24	1 460 100 674	02-33-224
2,26	1 460 100 675	02-33-226
2,28	1 460 100 676	02-33-228
2,30	1 460 100 677	02-33-230
2,32	1 460 100 678	02-33-232
2,34	1 460 100 679	02-33-234

codice singoli code individual		
misura	rif. originale	cod. OMS
2,36	1 460 100 680	02-33-236
2,38	1 460 100 681	02-33-238
2,40	1 460 100 682	02-33-240
2,42	1 460 100 683	02-33-242
2,44	1 460 100 684	02-33-244
2,46	1 460 100 685	02-33-246
2,48	1 460 100 686	02-33-248
2,50	1 460 100 687	02-33-250
2,52	1 460 100 688	02-33-252
2,54	1 460 100 689	02-33-254
2,56	1 460 100 690	02-33-256
2,58	1 460 100 691	02-33-258
2,60	1 460 100 692	02-33-260
2,62	1 460 100 693	02-33-262
2,64	1 460 100 694	02-33-264
2,66	1 460 100 695	02-33-266
2,68	1 460 100 696	02-33-268
2,70	1 460 100 697	02-33-270
2,72	1 460 100 698	02-33-272
2,74	1 460 100 699	02-33-274
2,76	1 460 100 700	02-33-276
2,78	1 460 100 701	02-33-278
2,80	1 460 100 702	02-33-280
2,82	1 460 100 703	02-33-282
2,84	1 460 100 704	02-33-284
2,86	1 460 100 705	02-33-286
2,88	1 460 100 706	02-33-288
2,90	1 460 100 707	02-33-290

Codice OMS	Spessore	Incremento	n° pezzi
02-20-012	da 1,92 a 2,90	0,02	500

valigetta 54 posizioni
handbag 54 position



VARI

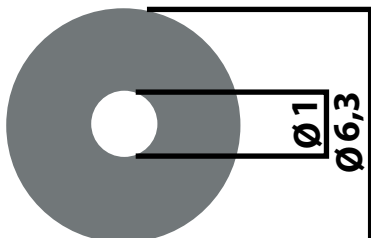

da 1,00.. a 2,00

ALTRE MISURE DISPONIBILI A RICHIESTA
Other sizes available upon request
Otros tamaños disponibles bajo petición
Другие размеры доступны по запросу
根据要求提供其它尺寸

Codice OMS	Spessore	Incremento	n° pezzi
02-20-018	da 1,00 a 1,95	0,01	960



valigetta 96 posizioni

codice singoli spessori code individual thicknesses	
misura	cod. OMS
1,00	02-20-018/100
1,01	02-20-018/101
1,02	02-20-018/102
1,03	02-20-018/103
1,04	02-20-018/104
1,05	02-20-018/105
1,06	02-20-018/106
1,07	02-20-018/107
1,08	02-20-018/108
1,09	02-20-018/109
1,10	02-20-018/110
1,11	02-20-018/111
1,12	02-20-018/112
1,13	02-20-018/113
1,14	02-20-018/114
1,15	02-20-018/115
1,16	02-20-018/116
1,17	02-20-018/117
1,18	02-20-018/118
1,19	02-20-018/119
1,20	02-20-018/120
1,21	02-20-018/121
1,22	02-20-018/122
1,23	02-20-018/123
1,24	02-20-018/124
1,25	02-20-018/125
1,26	02-20-018/126
1,27	02-20-018/127
1,28	02-20-018/128
1,29	02-20-018/129
1,30	02-20-018/130
1,31	02-20-018/131
1,32	02-20-018/132
1,33	02-20-018/133

codice singoli spessori code individual thicknesses	
misura	cod. OMS
1,34	02-20-018/134
1,35	02-20-018/135
1,36	02-20-018/136
1,37	02-20-018/137
1,38	02-20-018/138
1,39	02-20-018/139
1,40	02-20-018/140
1,41	02-20-018/141
1,42	02-20-018/142
1,43	02-20-018/143
1,44	02-20-018/144
1,45	02-20-018/145
1,46	02-20-018/146
1,47	02-20-018/147
1,48	02-20-018/148
1,49	02-20-018/149
1,50	02-20-018/150
1,51	02-20-018/151
1,52	02-20-018/152
1,53	02-20-018/153
1,54	02-20-018/154
1,55	02-20-018/155
1,56	02-20-018/156
1,57	02-20-018/157
1,58	02-20-018/158
1,59	02-20-018/159
1,60	02-20-018/160
1,61	02-20-018/161
1,62	02-20-018/162
1,63	02-20-018/163
1,64	02-20-018/164
1,65	02-20-018/165
1,66	02-20-018/166
1,67	02-20-018/167

codice singoli spessori code individual thicknesses	
misura	cod. OMS
1,68	02-20-018/168
1,69	02-20-018/169
1,70	02-20-018/170
1,71	02-20-018/171
1,72	02-20-018/172
1,73	02-20-018/173
1,74	02-20-018/174
1,75	02-20-018/175
1,76	02-20-018/176
1,77	02-20-018/177
1,78	02-20-018/178
1,79	02-20-018/179
1,80	02-20-018/180
1,81	02-20-018/181
1,82	02-20-018/182
1,83	02-20-018/183
1,84	02-20-018/184
1,85	02-20-018/185
1,86	02-20-018/186
1,87	02-20-018/187
1,88	02-20-018/188
1,89	02-20-018/189
1,90	02-20-018/190
1,91	02-20-018/191
1,92	02-20-018/192
1,93	02-20-018/193
1,94	02-20-018/194
1,95	02-20-018/195
2,00	02-20-018/200



BOSCH DOPPIA MOLLA

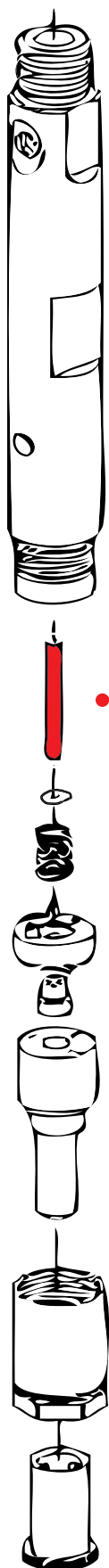

SPINA DI PRESSIONE
pressure pin
presión pin

da 43,80... a 44,78

ALTRE MISURE DISPONIBILI A RICHIESTA
Other sizes available upon request

Otros tamaños disponibles bajo petición

Другие размеры доступны по запросу

根据要求提供其它尺寸

Codice OMS	Spessore	Incremento	n° pezzi
02-20-013	da 43,80 a 44,78	0,02	500



valigetta 50 posizioni
handbag 50 position

codice singoli code individual		
misura	rif. originale	codice OMS
43,80	2 433 101 100	02-25-001
43,82	2 433 101 102	02-25-002
43,84	2 433 101 104	02-25-003
43,86	2 433 101 106	02-25-004
43,88	2 433 101 108	02-25-005
43,90	2 433 101 110	02-25-006
43,92	2 433 101 112	02-25-007
43,94	2 433 101 114	02-25-008
43,96	2 433 101 116	02-25-009
43,98	2 433 101 118	02-25-010
44,00	2 433 101 120	02-25-011
44,02	2 433 101 122	02-25-012
44,04	2 433 101 124	02-25-013
44,06	2 433 101 126	02-25-014
44,08	2 433 101 128	02-25-015
44,10	2 433 101 130	02-25-016
44,12	2 433 101 132	02-25-017
44,14	2 433 101 134	02-25-018
44,16	2 433 101 136	02-25-019
44,18	2 433 101 138	02-25-020
44,20	2 433 101 140	02-25-021
44,22	2 433 101 142	02-25-022
44,24	2 433 101 144	02-25-023
44,26	2 433 101 146	02-25-024
44,28	2 433 101 148	02-25-025
44,30	2 433 101 150	02-25-026
44,32	2 433 101 152	02-25-027
44,34	2 433 101 154	02-25-028
44,36	2 433 101 156	02-25-029
44,38	2 433 101 158	02-25-030
44,40	2 433 101 160	02-25-031
44,42	2 433 101 162	02-25-032
44,44	2 433 101 164	02-25-033
44,46	2 433 101 166	02-25-034
44,48	2 433 101 168	02-25-035
44,50	2 433 101 170	02-25-036
44,52	2 433 101 172	02-25-037
44,54	2 433 101 174	02-25-038
44,56	2 433 101 176	02-25-039
44,58	2 433 101 178	02-25-040
44,60	2 433 101 180	02-25-041
44,62	2 433 101 182	02-25-042
44,64	2 433 101 184	02-25-043
44,66	2 433 101 186	02-25-044
44,68	2 433 101 188	02-25-045
44,70	2 433 101 190	02-25-046
44,72	2 433 101 192	02-25-047
44,74	2 433 101 194	02-25-048
44,76	2 433 101 196	02-25-049
44,78	2 433 101 198	02-25-050



BOSCH DOPPIA MOLLA

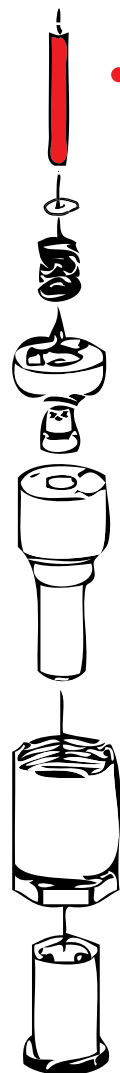
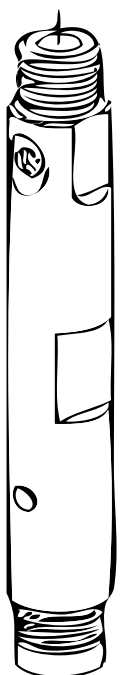

SPINA DI PRESSIONE
pressure pin
presión pin

da 33,80... a 34,80

ALTRE MISURE DISPONIBILI A RICHIESTA

Other sizes available upon request

Otros tamaños disponibles bajo petición

Другие размеры доступны по запросу

根据要求提供其它尺寸

Codice OMS	Spessore	Incremento	n° pezzi
02-20-014	da 33,80 a 34,78	0,02	500



valigetta 50 posizioni
handbag 50 position

codice singoli code individual		
misura	rif. originale	codice OMS
33,80	2 433 101 200	02-26-001
33,82	2 433 101 202	02-26-002
33,84	2 433 101 204	02-26-003
33,86	2 433 101 206	02-26-004
33,88	2 433 101 208	02-26-005
33,90	2 433 101 210	02-26-006
33,92	2 433 101 212	02-26-007
33,94	2 433 101 214	02-26-008
33,96	2 433 101 216	02-26-009
33,98	2 433 101 218	02-26-010
34,00	2 433 101 220	02-26-011
34,02	2 433 101 222	02-26-012
34,04	2 433 101 224	02-26-013
34,06	2 433 101 226	02-26-014
34,08	2 433 101 228	02-26-015
34,10	2 433 101 230	02-26-016
34,12	2 433 101 232	02-26-017
34,14	2 433 101 234	02-26-018
34,16	2 433 101 236	02-26-019
34,18	2 433 101 238	02-26-020
34,20	2 433 101 240	02-26-021
34,22	2 433 101 242	02-26-022
34,24	2 433 101 244	02-26-023
34,26	2 433 101 246	02-26-024
34,28	2 433 101 248	02-26-025
34,30	2 433 101 250	02-26-026
34,32	2 433 101 252	02-26-027
34,34	2 433 101 254	02-26-028
34,36	2 433 101 256	02-26-029
34,38	2 433 101 258	02-26-030
34,40	2 433 101 260	02-26-031
34,42	2 433 101 262	02-26-032
34,44	2 433 101 264	02-26-033
34,46	2 433 101 266	02-26-034
34,48	2 433 101 268	02-26-035
34,50	2 433 101 270	02-26-036
34,52	2 433 101 272	02-26-037
34,54	2 433 101 274	02-26-038
34,56	2 433 101 276	02-26-039
34,58	2 433 101 278	02-26-040
34,60	2 433 101 280	02-26-041
34,62	2 433 101 282	02-26-042
34,64	2 433 101 284	02-26-043
34,66	2 433 101 286	02-26-044
34,68	2 433 101 288	02-26-045
34,70	2 433 101 290	02-26-046
34,72	2 433 101 292	02-26-047
34,74	2 433 101 294	02-26-048
34,76	2 433 101 296	02-26-049
34,78	2 433 101 298	02-26-050
34,80	2 433 101 300	02-26-051



BOSCH DOPPIA MOLLA

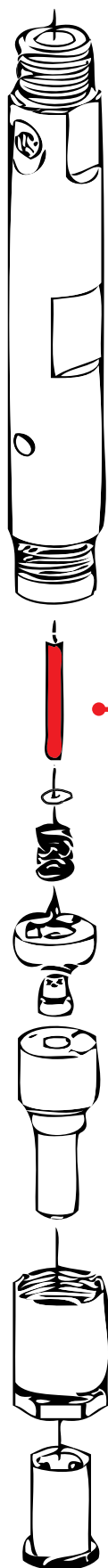

ASTA PRESSIONE
pressure pin
presión pin

da 28,19... a 29,49

ALTRE MISURE DISPONIBILI A RICHIESTA

Other sizes available upon request

Otros tamaños disponibles bajo petición

Другие размеры доступны по запросу

根据要求提供其它尺寸

Codice OMS	Spessore	Incremento	n° pezzi
02-20-015	da 28,35 a 29,33	0,02	5000



valigetta 50 posizioni
handbag 50 position

codice singoli
code individual

misura	rif. originale	codice OMS
28,19	2 433 101 580	02-27-001
28,21	2 433 101 578	02-27-002
28,23	2 433 101 576	02-27-003
28,25	2 433 101 574	02-27-004
28,27	2 433 101 572	02-27-005
28,29	2 433 101 570	02-27-006
28,31	2 433 101 568	02-27-007
28,33	2 433 101 566	02-27-008
28,35	2 433 101 564	02-27-009
28,37	2 433 101 562	02-27-010
28,39	2 433 101 560	02-27-011
28,41	2 433 101 558	02-27-012
28,43	2 433 101 556	02-27-013
28,45	2 433 101 554	02-27-014
28,47	2 433 101 552	02-27-015
28,49	2 433 101 550	02-27-016
28,51	2 433 101 302	02-27-017

codice singoli
code individual

misura	rif. originale	codice OMS
28,53	2 433 101 304	02-27-018
28,55	2 433 101 306	02-27-019
28,57	2 433 101 308	02-27-020
28,59	2 433 101 310	02-27-021
28,61	2 433 101 312	02-27-022
28,63	2 433 101 314	02-27-023
28,65	2 433 101 316	02-27-024
28,67	2 433 101 318	02-27-025
28,69	2 433 101 320	02-27-026
28,71	2 433 101 322	02-27-027
28,73	2 433 101 324	02-27-028
28,75	2 433 101 326	02-27-029
28,77	2 433 101 328	02-27-030
28,79	2 433 101 330	02-27-031
28,81	2 433 101 332	02-27-032
28,83	2 433 101 334	02-27-033
28,85	2 433 101 336	02-27-034
28,87	2 433 101 338	02-27-035
28,89	2 433 101 340	02-27-036
28,91	2 433 101 342	02-27-037
28,93	2 433 101 344	02-27-038
28,95	2 433 101 346	02-27-039
28,97	2 433 101 348	02-27-040
28,99	2 433 101 350	02-27-041
29,01	2 433 101 352	02-27-042
29,03	2 433 101 354	02-27-043
29,05	2 433 101 356	02-27-044
29,07	2 433 101 358	02-27-045
29,09	2 433 101 360	02-27-046
29,11	2 433 101 362	02-27-047
29,13	2 433 101 364	02-27-048
29,15	2 433 101 366	02-27-049
29,17	2 433 101 368	02-27-050
29,19	2 433 101 370	02-27-051
29,21	2 433 101 372	02-27-052
29,23	2 433 101 374	02-27-053
29,25	2 433 101 376	02-27-054
29,27	2 433 101 378	02-27-055
29,29	2 433 101 380	02-27-056
29,31	2 433 101 382	02-27-057
29,33	2 433 101 384	02-27-058
29,35	2 433 101 386	02-27-059
29,37	2 433 101 388	02-27-060
29,39	2 433 101 390	02-27-061
29,41	2 433 101 392	02-27-062
29,43	2 433 101 394	02-27-063
29,45	2 433 101 396	02-27-064
29,47	2 433 101 398	02-27-065
29,49	2 433 101 400	02-27-066



BOSCH POMPA P

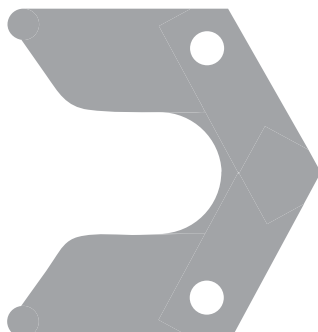

PIASTRINA COMPENSAZIONE
compensation plate
compensación de la placa

da 0,40 ... a 2,50

ALTRE MISURE DISPONIBILI A RICHIESTA
Other sizes available upon request
Otros tamaños disponibles bajo petición
Другие размеры доступны по запросу
根据要求提供其它尺寸

Codice OMS	Spessore	Incremento	n° pezzi
02-20-010	da 0,40 a 2,50	0,05	430



valigetta 50 posizioni
handbag 50 position

codice singoli
code individual

misura	rif. originale	codice OMS
0,40	2 411 098 010	03-02-159
0,45	2 411 098 011	03-02-160
0,50	2 411 098 012	03-02-161
0,55	2 411 098 013	03-02-162
0,60	2 411 098 014	03-02-163
0,65	2 411 098 015	03-02-164
0,70	2 411 098 016	03-02-165
0,75	2 411 098 017	03-02-166
0,80	2 411 098 018	03-02-167
0,85	2 411 098 019	03-02-168
0,90	2 411 098 020	03-02-169
0,95	2 411 098 021	03-02-170
1,00	2 411 098 022	03-02-171
1,05	2 411 098 023	03-02-172
1,10	2 411 098 024	03-02-173
1,15	2 411 098 025	03-02-174
1,20	2 411 098 026	03-02-175
1,25	2 411 098 027	03-02-176
1,30	2 411 098 028	03-02-177
1,35	2 411 098 029	03-02-178
1,40	2 411 098 030	03-02-179
1,45	2 411 098 031	03-02-180
1,50	2 411 098 032	03-02-181
1,55	2 411 098 033	03-02-182
1,60	2 411 098 034	03-02-183
1,65	2 411 098 035	03-02-184
1,70	2 411 098 036	03-02-185
1,75	2 411 098 037	03-02-186
1,80	2 411 098 038	03-02-187
1,85	2 411 098 039	03-02-188
1,90	2 411 098 040	03-02-189
1,95	2 411 098 041	03-02-190
2,00	2 411 098 042	03-02-191
2,05	2 411 098 043	03-02-192
2,10	2 411 098 044	03-02-193
2,15	2 411 098 045	03-02-194
2,20	2 411 098 046	03-02-195
2,25	2 411 098 047	03-02-196
2,30	2 411 098 048	03-02-197
2,35	2 411 098 049	03-02-198
2,40	2 411 098 050	03-02-199
2,45	2 411 098 051	03-02-200
2,50	2 411 098 052	03-02-201



NAVISTAR POWERSTROKE 7.3

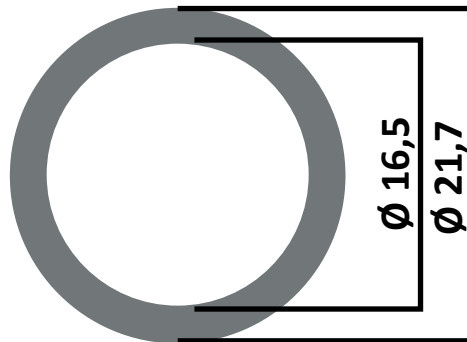

da 2,00.. a 2,23

ALTRE MISURE DISPONIBILI A RICHIESTA

Other sizes available upon request

Otros tamaños disponibles bajo petición

Другие размеры доступны по запросу

根据要求提供其它尺寸



Codice OMS	Spessore	Incremento	n° pezzi
11-23-647	da 2,00 a 2,23	0,01	240



valigetta 24 posizioni
handbag 24 position

codice singoli
code individual

misura	cod. OMS	misura	cod. OMS
2,00	11-23-647/200	2,12	11-23-647/212
2,01	11-23-647/201	2,13	11-23-647/213
2,02	11-23-647/202	2,14	11-23-647/214
2,03	11-23-647/203	2,15	11-23-647/215
2,04	11-23-647/204	2,16	11-23-647/216
2,05	11-23-647/205	2,17	11-23-647/217
2,06	11-23-647/206	2,18	11-23-647/218
2,07	11-23-647/207	2,19	11-23-647/219
2,08	11-23-647/208	2,20	11-23-647/220
2,09	11-23-647/209	2,21	11-23-647/221
2,10	11-23-647/210	2,22	11-23-647/222
2,11	11-23-647/211	2,23	11-23-647/223

NAVISTAR POWERSTROKE 7.3

da 2,00.. a 2,47

ALTRE MISURE DISPONIBILI A RICHIESTA
Other sizes available upon request

Otros tamaños disponibles bajo petición
Другие размеры доступны по запросу

根据要求提供其它尺寸

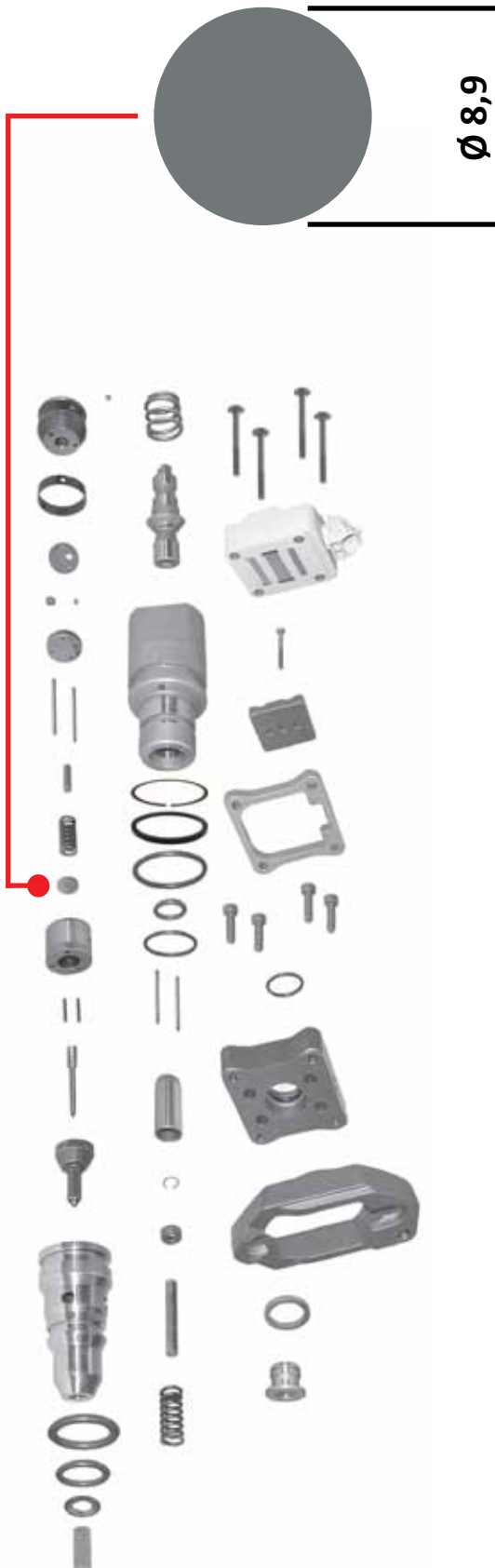

Codice OMS	Spessore	Incremento	n° pezzi
11-23-648	da 2,00 a 1,70	0,01	480



valigetta 54posizioni
handbag 54 position

codice singoli spessori
code individual thicknesses

misura	cod. OMS	misura	cod. OMS
2,00	11-23-648/200	2,24	11-23-648/224
2,01	11-23-648/201	2,25	11-23-648/225
2,02	11-23-648/202	2,26	11-23-648/226
2,03	11-23-648/203	2,27	11-23-648/227
2,04	11-23-648/204	2,28	11-23-648/228
2,05	11-23-648/205	2,29	11-23-648/229
2,06	11-23-648/206	2,30	11-23-648/230
2,07	11-23-648/207	2,31	11-23-648/231
2,08	11-23-648/208	2,32	11-23-648/232
2,09	11-23-648/209	2,33	11-23-648/233
2,10	11-23-648/210	2,34	11-23-648/234
2,11	11-23-648/211	2,35	11-23-648/235
2,12	11-23-648/212	2,36	11-23-648/236
2,13	11-23-648/213	2,37	11-23-648/237
2,14	11-23-648/214	2,38	11-23-648/238
2,15	11-23-648/215	2,39	11-23-648/239
2,16	11-23-648/216	2,40	11-23-648/240
2,17	11-23-648/217	2,41	11-23-648/241
2,18	11-23-648/218	2,42	11-23-648/242
2,19	11-23-648/219	2,43	11-23-648/243
2,20	11-23-648/220	2,44	11-23-648/244
2,21	11-23-648/221	2,45	11-23-648/245
2,22	11-23-648/222	2,46	11-23-648/246
2,23	11-23-648/223	2,47	11-23-648/247



CATERPILLAR 3406 E

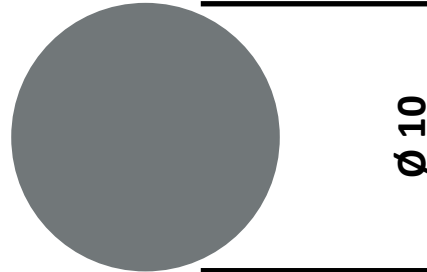
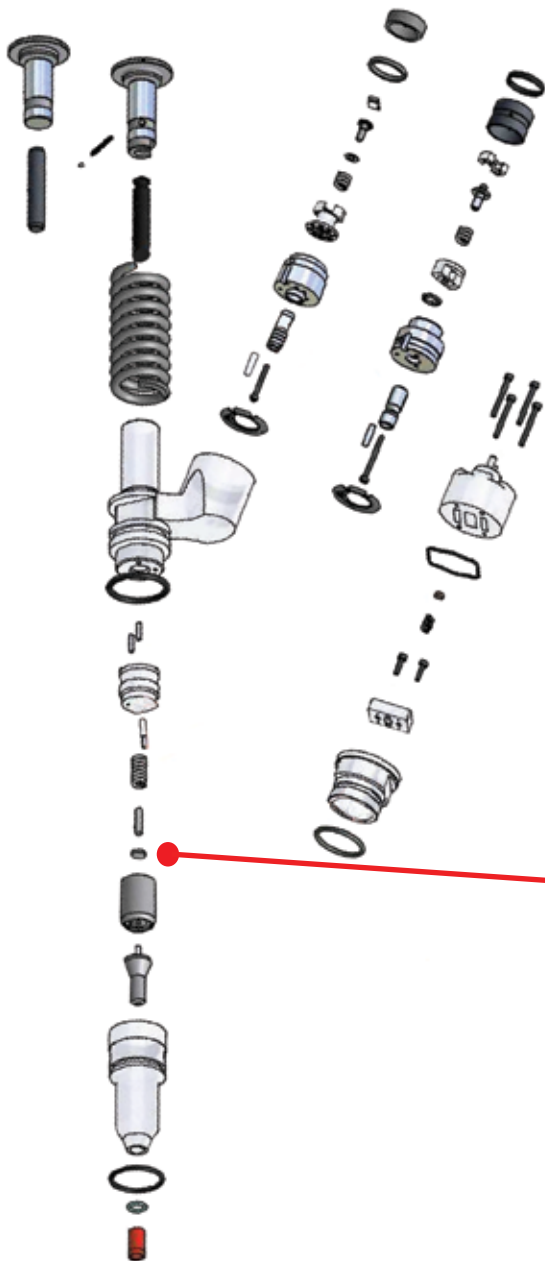

da 2,00.. a 2,50

ALTRE MISURE DISPONIBILI A RICHIESTA

Other sizes available upon request

Otros tamaños disponibles bajo petición

Другие размеры доступны по запросу

根据要求提供其它尺寸



codice singoli spessori
code individual thicknesses

misura	cod. OMS	misura	cod. OMS
2,00	11-23-649/200	2,30	11-23-649/230
2,05	11-23-649/205	2,35	11-23-649/235
2,10	11-23-649/210	2,40	11-23-649/240
2,15	11-23-649/215	2,45	11-23-649/245
2,20	11-23-649/220	2,50	11-23-649/250
2,25	11-23-649/225		



CATERPILLAR 3406 E

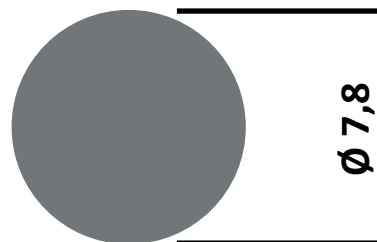
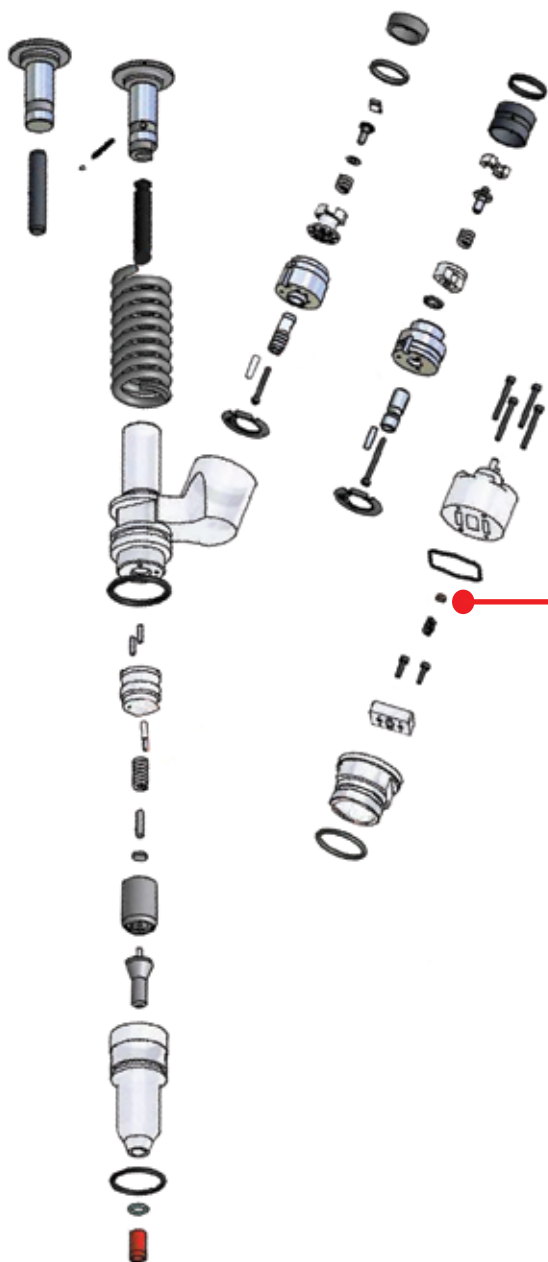

Ø 7,8

da 2,20.. a 3,25

ALTRE MISURE DISPONIBILI A RICHIESTA

Other sizes available upon request

Otros tamaños disponibles bajo petición

Другие размеры доступны по запросу

根据要求提供其它尺寸

Codice OMS	Spessore	Incremento	n° pezzi
11-23-650	da 2,20 a 3,25	0,05	220



valigetta 24 posizioni
handbag 24 position

codice singoli spessori
code individual thicknesses

misura	cod. OMS	misura	cod. OMS
2,20	11-23-650/220	2,75	11-23-650/275
2,25	11-23-650/225	2,80	11-23-650/280
2,30	11-23-650/230	2,85	11-23-650/285
2,35	11-23-650/235	2,90	11-23-650/290
2,40	11-23-650/240	2,95	11-23-650/295
2,45	11-23-650/245	3,00	11-23-650/300
2,50	11-23-650/250	3,05	11-23-650/305
2,55	11-23-650/255	3,10	11-23-650/310
2,60	11-23-650/260	3,15	11-23-650/315
2,65	11-23-650/265	3,20	11-23-650/320
2,70	11-23-650/270	3,25	11-23-650/325



BOSCH **OMS** srl DIESEL SPARE PARTS **CUMMINS**
ITALY

DENSO **NAVISTAR**
CATALOGO RICAMBI INIETTORI
INJECTOR DIESEL SPARE
PARTS CATALOGUE

DELPHI **DETROIT DIESEL**
SIEMENS **CATERPILLAR**

VERSIONE 10.0

BOSCH **OMS** srl DIESEL SPARE PARTS **BOSCH**
ITALY

SIEMENS
CATALOGO SPESSORI
CALIBRATION SHIMS
SUPLEMENTOS DE CALIBRACIÓN
калибровки прокладки
校準墊片

DENSO **DELPHI**

VERSIONE 12.1

VERSIONE 13.0

BOSCH **OMS** srl DIESEL SPARE PARTS **CUMMINS**
ITALY

NAVISTAR
CATALOGO POMPE
PUMPS CATALOGUE

BOSCH **OMS** srl DIESEL SPARE PARTS **BOSCH**
ITALY

SIEMENS
CATALOGO KIT
KIT CATALOGUE

VERSIONE 14.0



Via Piave 15 - 25015 Desenzano del Garda (Brescia) Italia
Tel. +39 030 9127051 - Fax +39 030 9124070
oms@omsnet.it - www.omsnet.it